

ZOCCOLO H 10-15 cm

Zoccolo da cucina H 10-15 cm.

PLINTH H 10-15 cm

Plinth for kitchen height 10-15 cm.

SOCKEL H 10-15 cm

Sockel für Küche Höhe 10-15 cm.

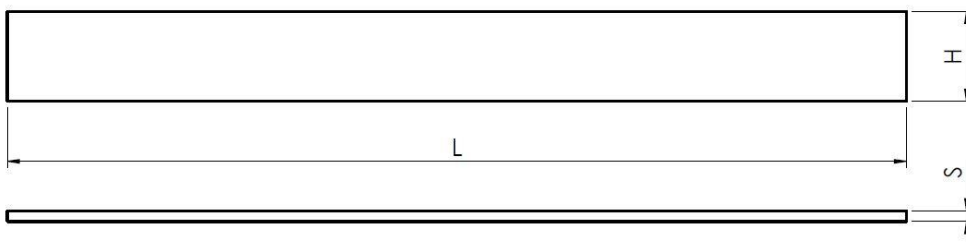
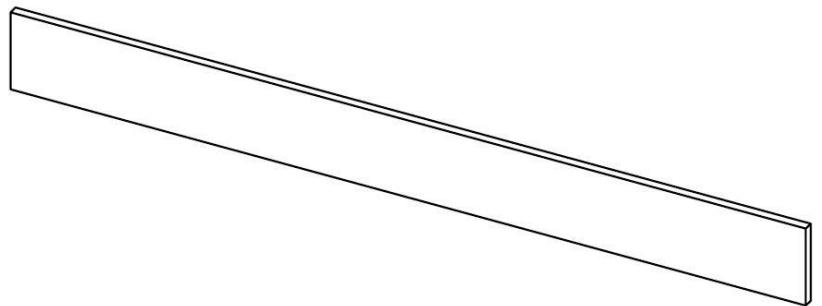

TAMPONAMENTO

Tamponamento per cucina.

FILLER

Filler for kitchens.

FILLER

Filler für Küche.

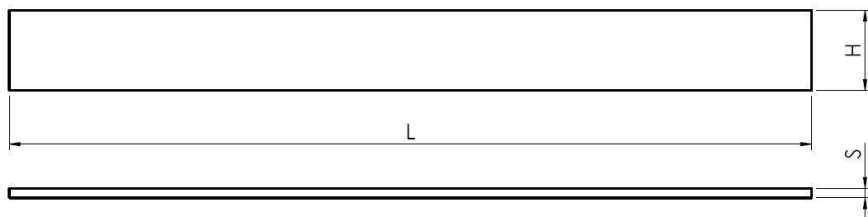
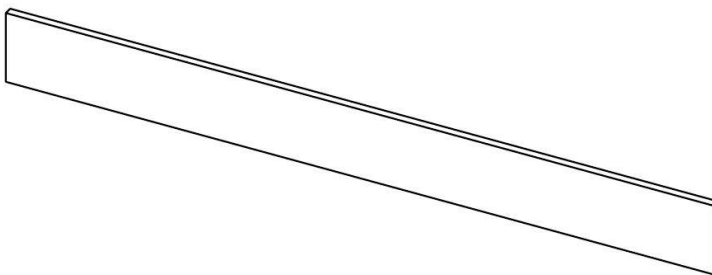

MENSOLA SPESSORE 28 mm

Mensola spessore 28 mm.

SHELF THICKNESS 28 mm

Shelf thickness 28 mm.

REGAL STAERKE 28 mm

Regal Stärke 28 mm.

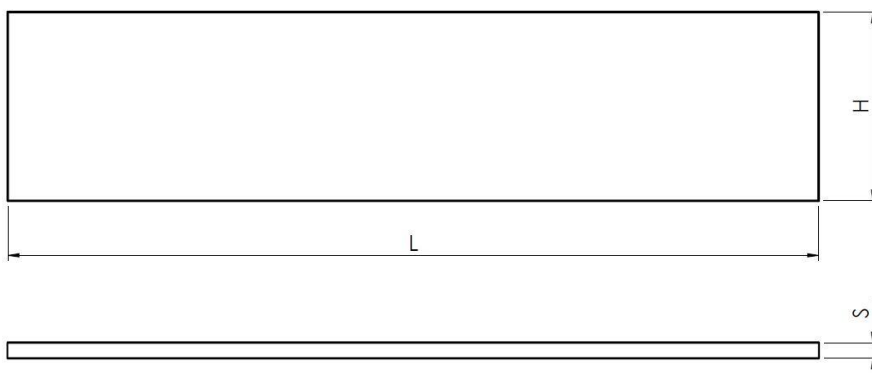
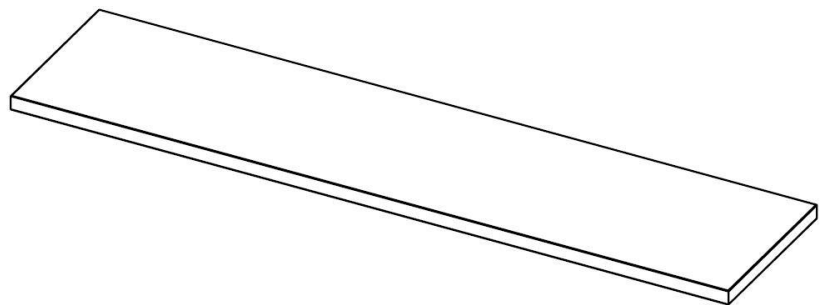

PANNELLO CON BORDO SINISTRO 45° E SUPERIORE 30°

Pannello per basi, pensili o isole con bordo sinistro a 45° e bordo superiore 30°.

Materiali disponibili: Impiallacciato, Laccato, Biomalta.

PANEL WITH 1 LEFT EDGE 45° AND TOP EDGE 30°

Panel for base, wall panel or counter kitchen island with 1 left edge 45° and top edge 30°.

Available materials: Veneered doors, Lacquered doors, Bio mortar doors.

PANEEL MIT 1 LINKE SEITE 45° UND OBERE SEITE 30°

Basis und Wand Paneele oder Paneele fuer Kücheninsel mit 1 linke Seite 45° und obere Seite 30°.

Verfügbare Materialien: Furnierten fronten, Lackierte fronten, Oeko-Moertel fronten.

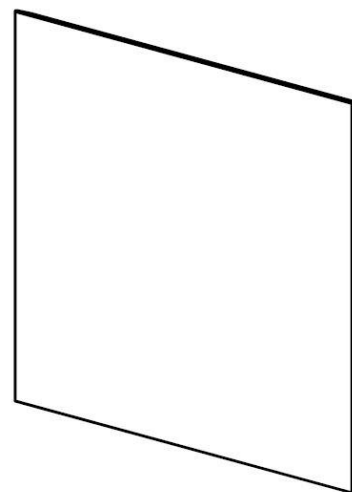
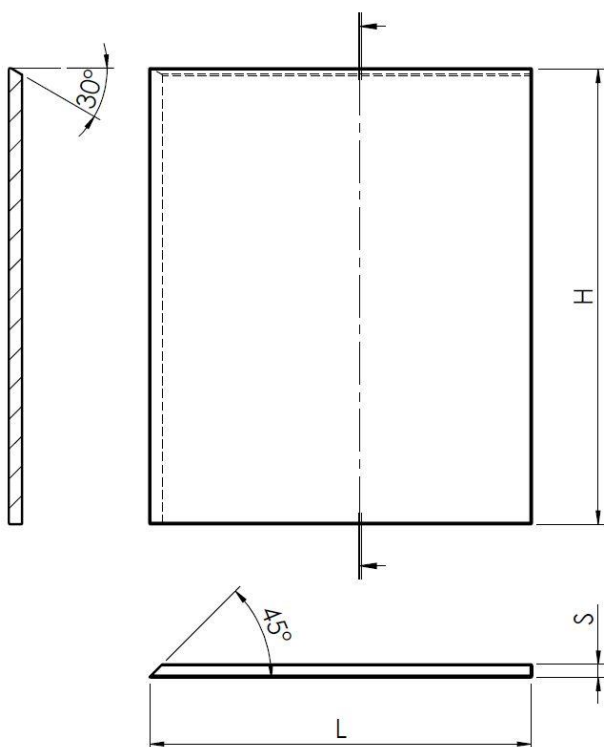

PANNELLO CON BORDO DESTRO 45° E SUPERIORE 30°

Pannello per basi, pensili o isole con bordo destro a 45° e bordo superiore 30°.

Materiali disponibili: Impiallacciato, Laccato, Biomalta.

PANEL WITH 1 RIGHT EDGE 45° AND TOP EDGE 30°

Panel for base, wall panel or counter kitchen island with 1 right edge 45° and top edge 30°.

Available materials: Veneered doors, Lacquered doors, Bio mortar doors.

PANEEL MIT 1 RECHTE SEITE 45° UND OBERE SEITE 30°

Basis und Wand Paneele oder Paneele fuer Kücheninsel mit 1 rechte Seite 45° und obere Seite 30°.

Verfügbare Materialien: Furnierten fronten, Lackierte fronten, Oeko-Moertel fronten.

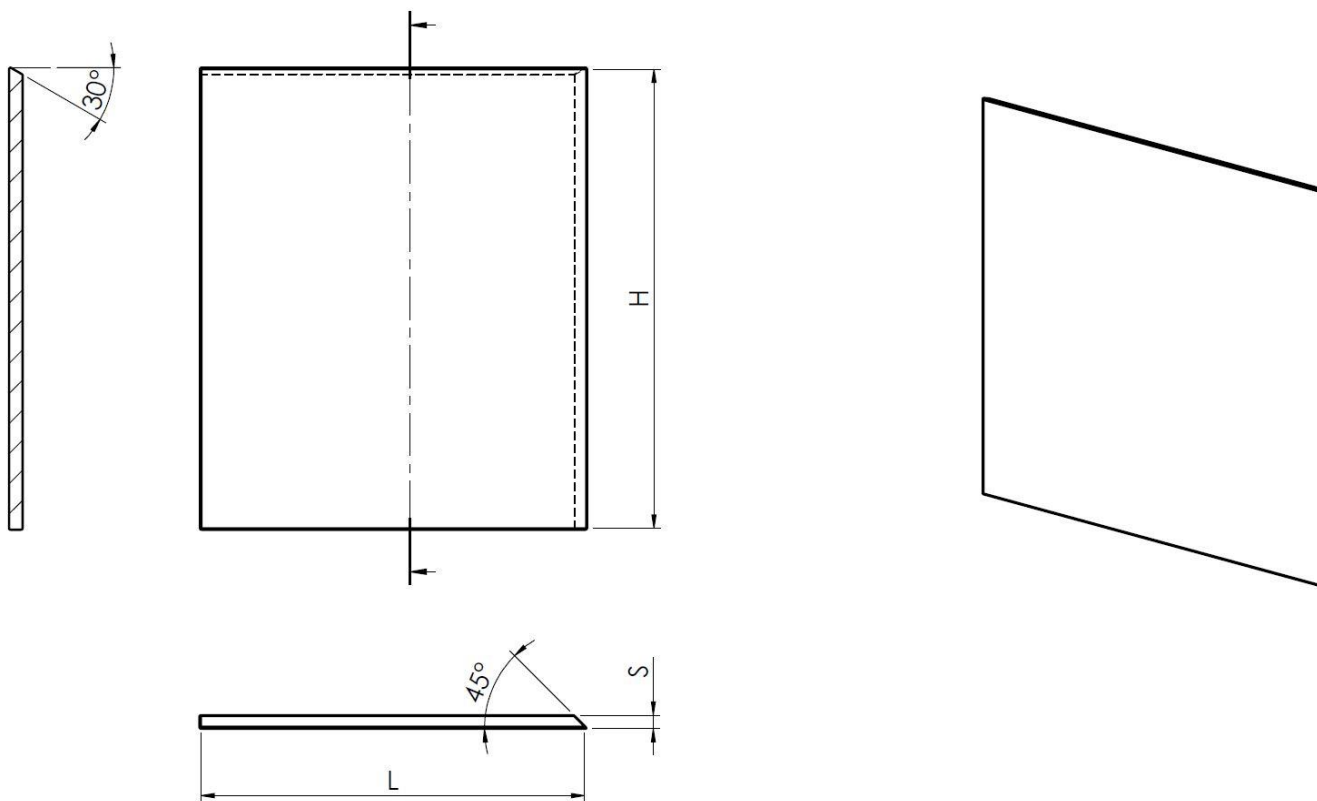

PANNELLO CON 2 LATI 45° E SUP SLAB

Pannello con 2 lati a 45° e bordo superiore Slab.

Materiali disponibili: Impiallacciato, Laccato, Biomalta.

PANEL WITH 1 SIDES 45° AND TOP EDGE SLAB

Panel for base, wall panel or counter kitchen island with 2 sides 45° and top edge Slab Profile.

Available materials: Veneered doors, Lacquered doors, Bio mortar doors.

PANEEL MIT 2 SEITEN 45° UND OBERE SEITE SLAB

Basis und Wand Paneele oder Paneele fuer Kücheninsel mit 2 Seiten 45° und obere Seite Slab Profil.

Verfügbare Materialien: Furnierten fronten, Lackierte fronten, Oeko-Moertel fronten.

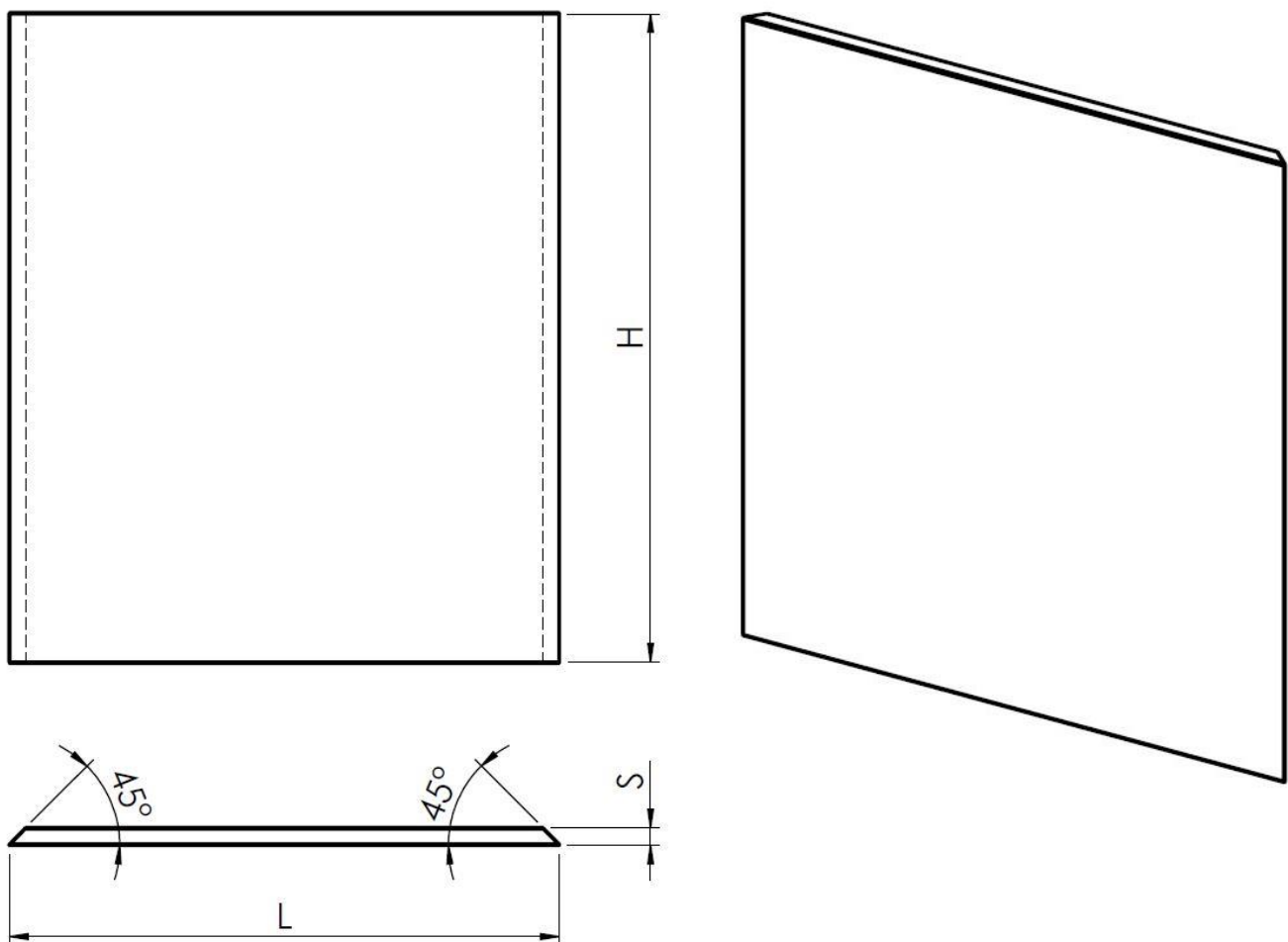

PANNELLO CON 2 LATI 45° E SUP 30°

Pannello con 2 lati a 45° e bordo superiore 30°.

PANEL WITH 2 SIDES 45° AND TOP EDGE 30°

Panel for base, wall panel or counter kitchen island with 2 sides 45° and top edge 30°.

PANEEL MIT 2 SEITEN 45° UND OBERE SEITE 30°

Basis und Wand Paneele oder Paneele fuer Kücheninsel mit 2 Seiten 45° und obere Seite 30°.

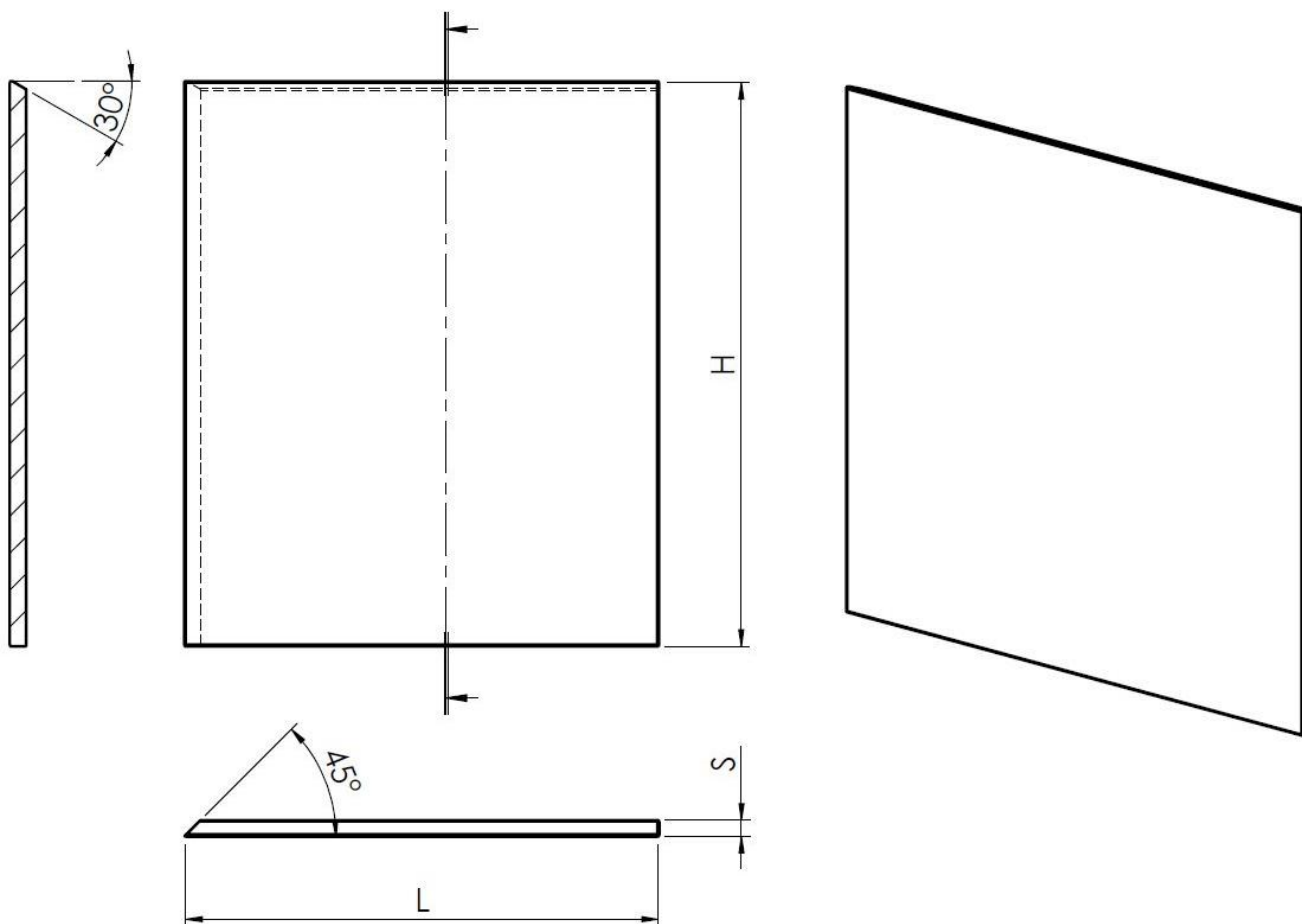

MONTANTE ANGOLO INTERNO SLAB

Montante angolo interno con profilo Slab.

INTERNAL CORNER POST SLAB

Internal Corner post Slab profile.

INNERE ECKE PASSTUECK, SLAB PROFIL

Innere Ecke Passtueck mit Slab Profil.

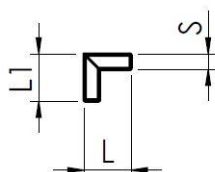
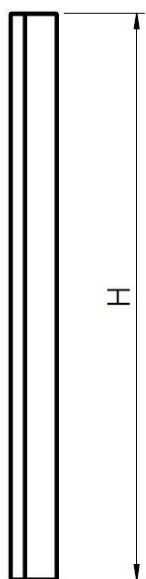

MONTANTE ANGOLO INTERNO 30°

Montante angolo interno con profilo Chamfer 30°.

INTERNAL CORNER POST 30°, CHAMFER PROFILE

Internal Corner post 30°, Chamfer profile.

INNERE ECKE PASSTUECK 30°, CHAMFER PROFIL

Innere Ecke Passtueck mit 30°, Chamfer Profil.

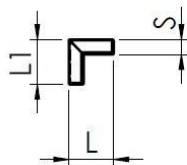
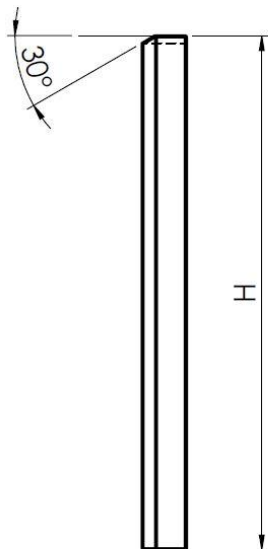

MONTANTE ANGOLO INTERNO JPULL

Montante angolo interno con profilo Jpull.

INTERNAL CORNER POST JPULL

Internal Corner post Jpull profile.

INNERE ECKE PASSTUECK, JPULL PROFIL

Innere Ecke Passtueck mit Jpull Profil.

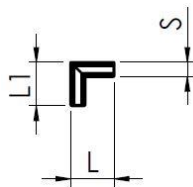
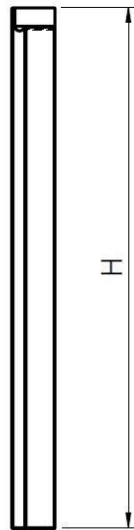

MONTANTE ANGOLO ESTERNO SLAB

Montante angolo esterno con profilo Slab.

EXTERNAL CORNER POST SLAB

External Corner post Slab profile.

AUSSERE ECKE PASSTUECK, SLAB PROFIL

Aussere Ecke Passtueck mit Slab Profil.

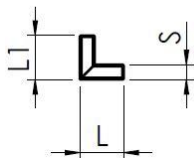
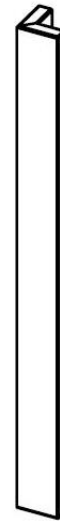
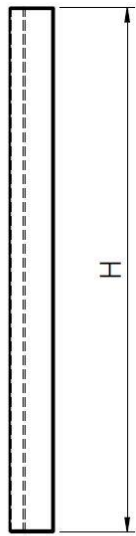

MONTANTE ANGOLO ESTERNO 30°

Montante angolo esterno con profilo 30° Chamfer.

EXTERNAL CORNER POST 30°

External Corner post 30° Chamfer Profile.

AUSSERE ECKE PASSTUECK, 30°PROFIL

Aussere Ecke Passtueck mit 30° Chamfer Profil.

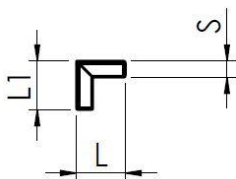
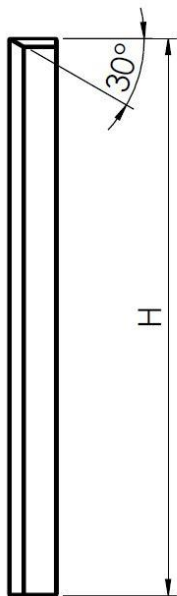

MONTANTE ANGOLO ESTERNO JPULL

Montante angolo esterno con profilo Jpull.

EXTERNAL CORNER POST JPULL

External Corner post Jpull profile.

AUSSERE ECKE PASSTUECK, JPULL PROFIL

Aussere Ecke Passtueck mit Jpull Profil.

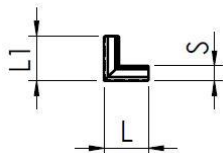
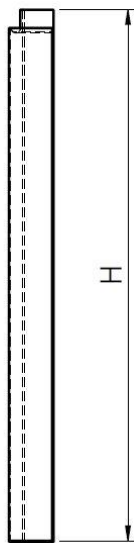

PANNELLO L BASE E PENSILE SLAB

Pannello a L per basi, pensili o isole con bordo Slab.

L SHAPE BASE/WALL PANEL, SLAB PROFILE

L shape base/wall panel or for counter kitchen island with slab profile.

L BASIS UND WAND PANEEL, OBERE SEITE SLAB

L Basis und Wand Paneel oder für Kücheninsel mit Slab Profil.

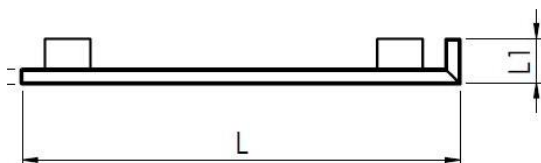
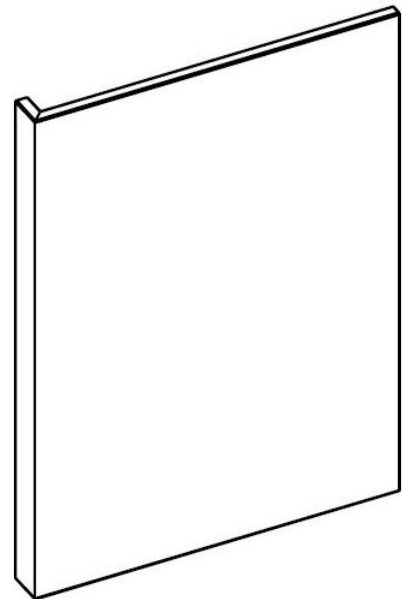
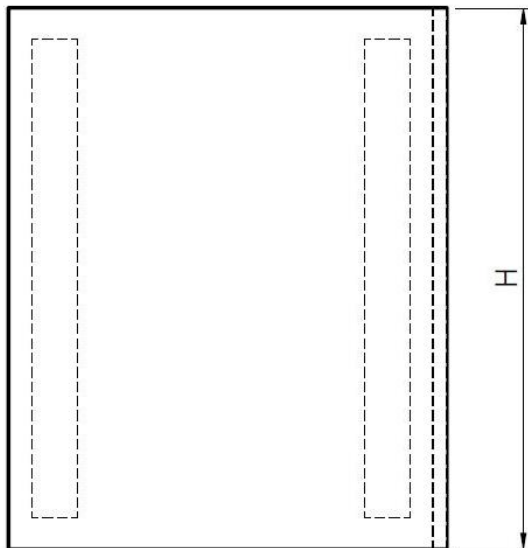

PANNELLO L BASE DX BORDO SUPERIORE 30°

Pannello a L destro per basi o isole, bordo superiore 30°.

L SHAPE BASE RIGHT PANEL, TOP EDGE 30°

L shape right panel for base and counter kitchen island, top edge 30°.

L RECHTE BASIS PANEEL, OBERE SEITE 30°

L rechte Basis Paneel oder für Kücheninsel mit 30° Profil.

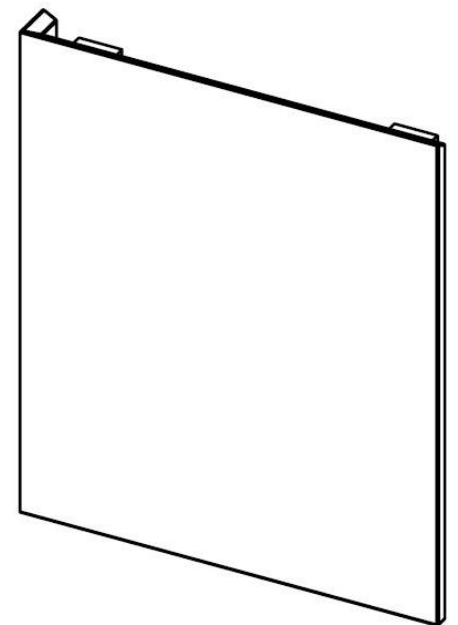
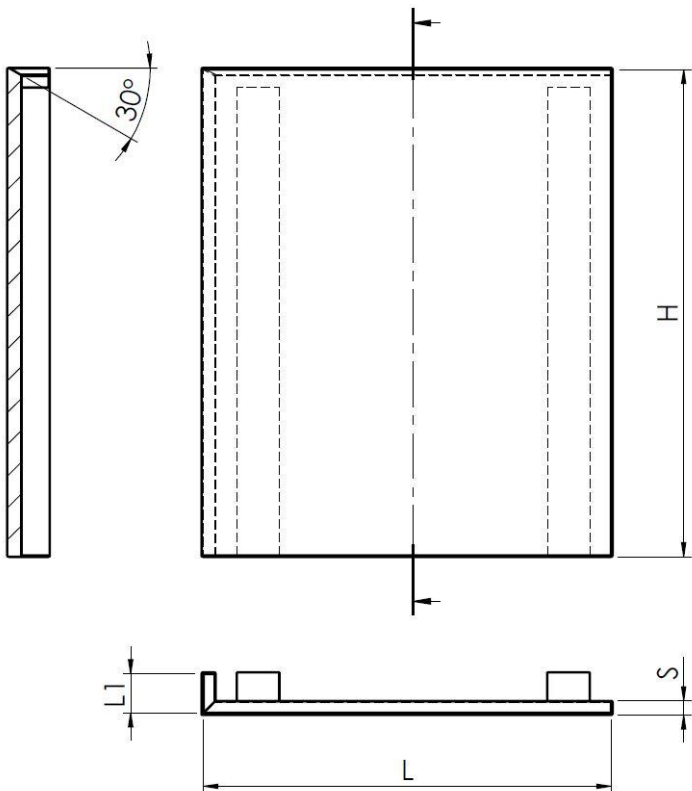

PANNELLO L BASE SX BORDO SUPERIORE 30°

Pannello a L sinistro per basi o isole, bordo superiore 30°.

L SHAPE BASE LEFT PANEL, TOP EDGE 30°

L shape left panel for base and counter kitchen island, top edge 30°.

L LINKS BASIS PANEEL, OBERE SEITE 30°

L linke Basis Paneel oder für Kücheninsel mit 30° Profil.

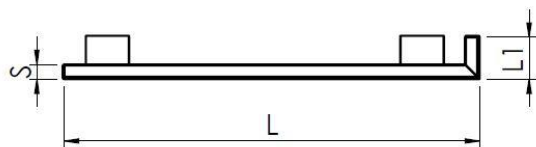
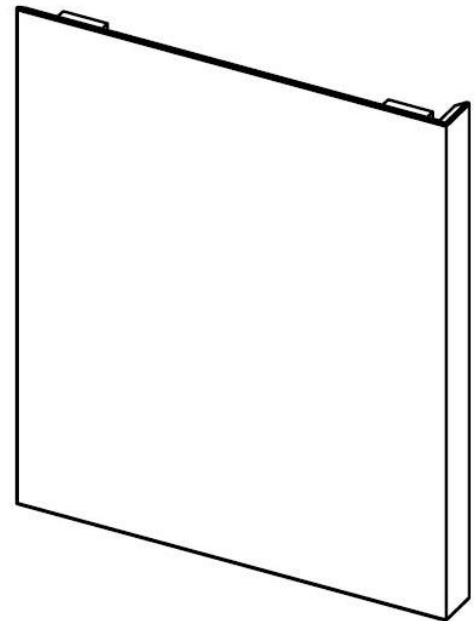
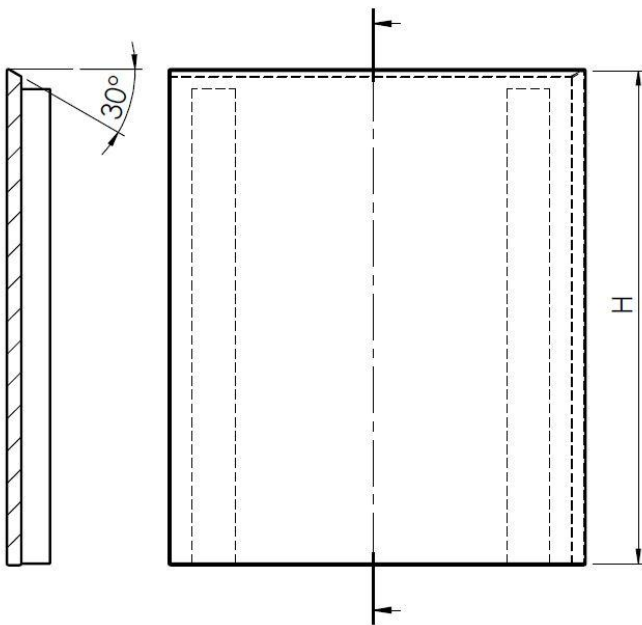

PANNELLO L BASE DX BORDO SUPERIORE GOLA1

Pannello a L destro per basi o isole, bordo superiore Gola1.

L SHAPE BASE RIGHT PANEL, TOP EDGE JPULL

L shape right panel for base and counter kitchen island, top edge jpull

L RECHTE BASIS PANEEL, OBERE SEITE 30°

L rechte Basis Paneel oder für Kücheninsel mit jpull Profil.

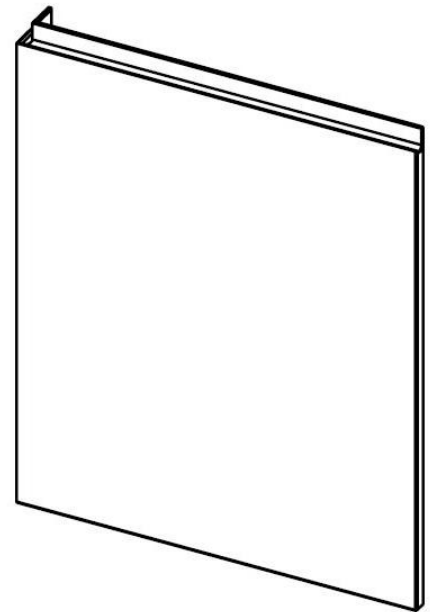
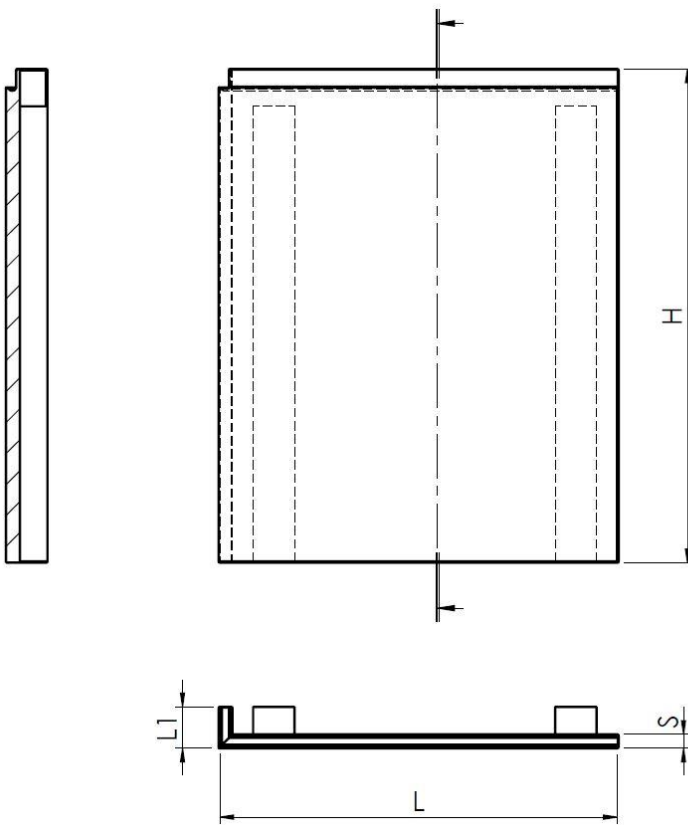

PANNELLO L BASE SX BORDO SUPERIORE GOLA1

Pannello a L sinistro per basi o isole, bordo superiore Gola1.

L SHAPE BASE LEFT PANEL, TOP EDGE JPULL

L shape left panel for base and counter kitchen island, top edge jpull.

L LINKS BASIS PANEEL, OBERE SEITE JPULL

L linke Basis Paneel oder für Kücheninsel mit Jpull Profil.

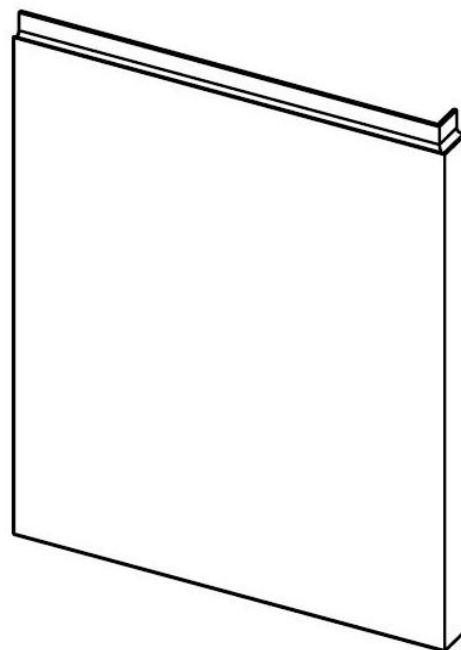
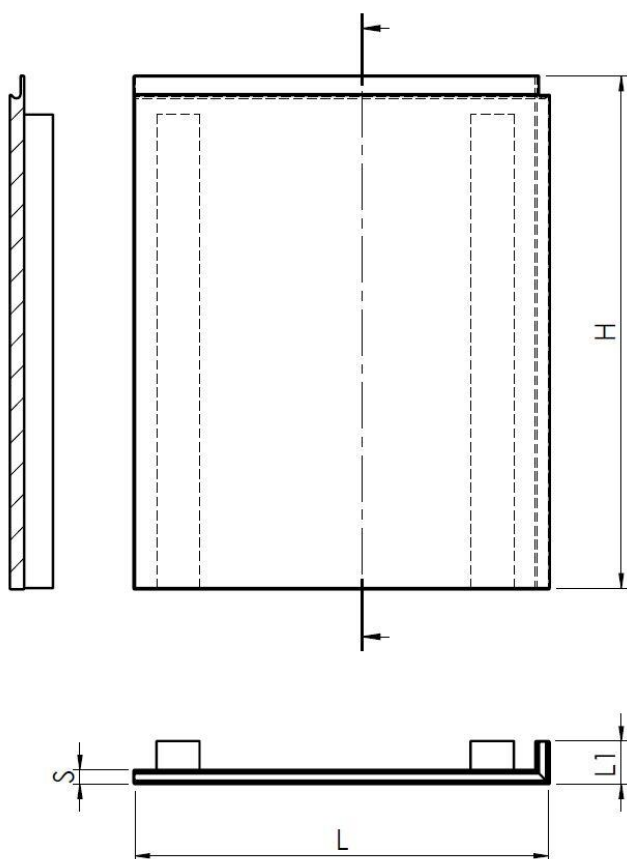

PANNELLO L PENSILE SX BORDO INFERIORE 30°

Pannello a L sinistro per pensile, bordo inferiore 30°.

L SHAPE WALL LEFT PANEL, BOTTOM EDGE 30°

L shape left panel for shape wall panel, bottom edge 30°.

L LINKS WAND PANEEL, UNTERE SEITE 30°

L links Wand Paneel mit untere Seite 30° Profil.

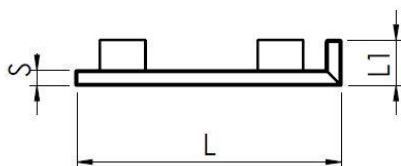
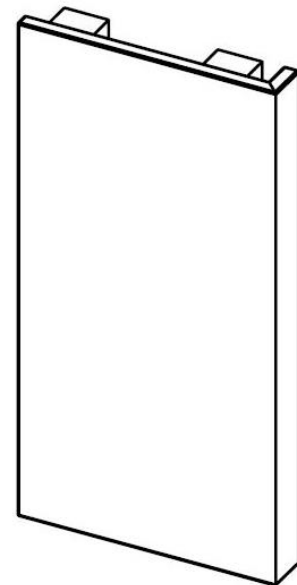
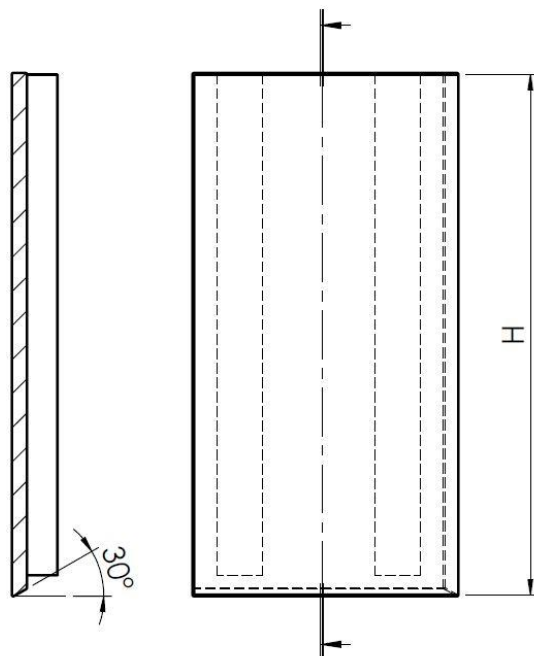

PANNELLO L PENSILE DX BORDO INFERIORE 30°

Pannello a L destro per pensili, bordo inferiore 30°.

L SHAPE WALL RIGHT PANEL, BOTTOM EDGE 30°

L shape wall right panel, bottom edge 30°.

L RECHTE WAND PANEEL, UNTERE SEITE 30°

L rechte Wand Paneel mit 30° Profil.

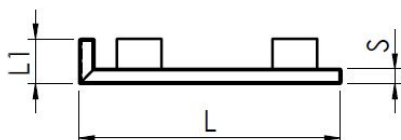
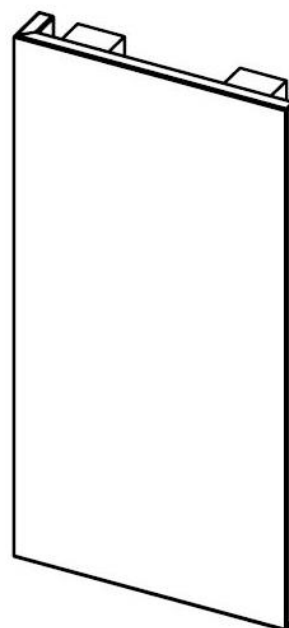
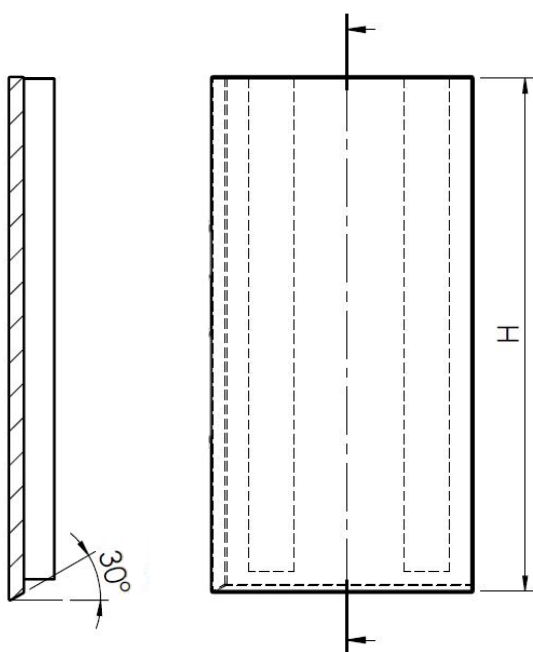

PANNELLO L PENSILE SX BORDO INFERIORE GOLA1

Pannello a L sinistro per pensile, bordo inferiore Gola1.

L SHAPE WALL LEFT PANEL, BOTTOM EDGE JPULL

L shape left panel for shape wall panel, bottom edge jpull.

L LINKS WAND PANEEL, UNTERE JPULL

L links Wand Paneel mit untere Seite Jpull Profil.

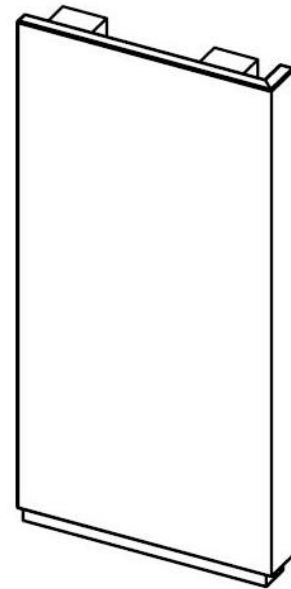
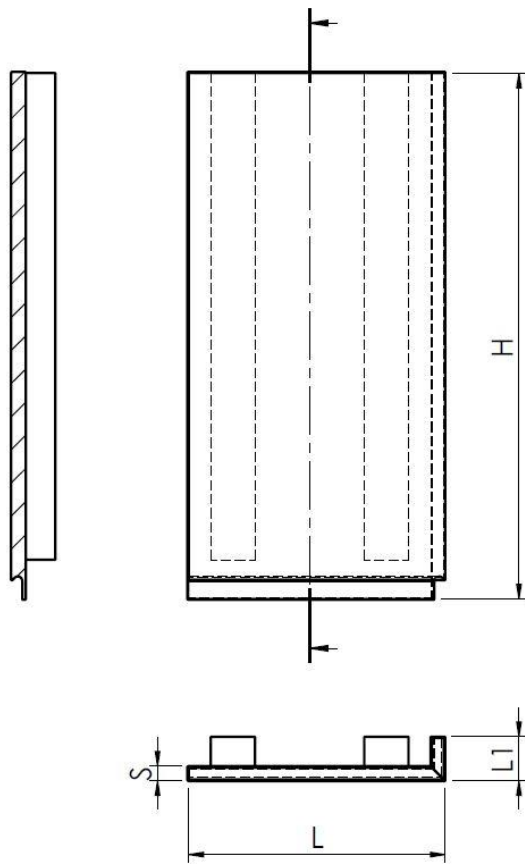

PANNELLO L PENSILE DX BORDO INFERIORE GOLA1

Pannello a L destro per pensili, bordo inferiore Gola.

L SHAPE WALL RIGHT PANEL, BOTTOM EDGE JPULL

L shape wall right panel, bottom edge jpull.

L RECHTE WAND PANEEL, UNTERE SEITE JPULL

L rechte Wand Paneel mit Jpull Profil.

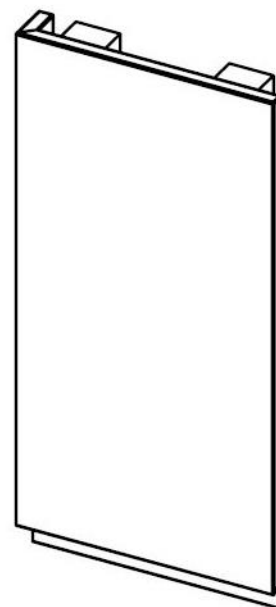
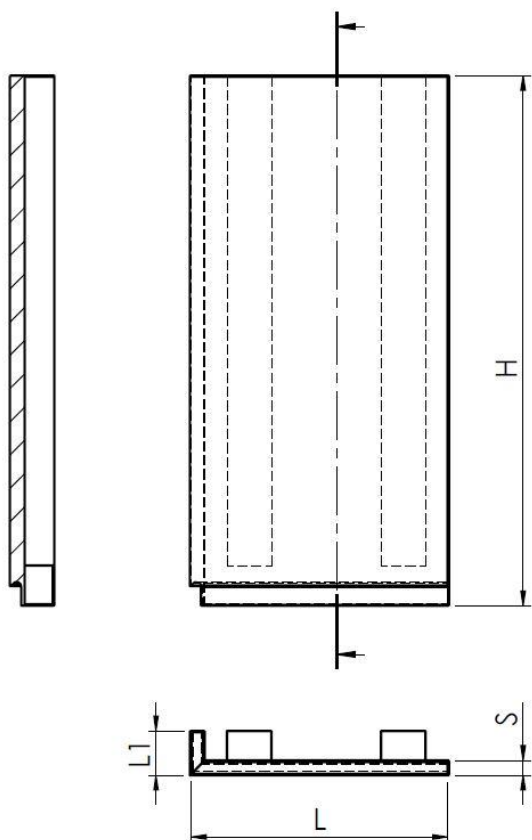

PANNELLO U BASE SLAB

Pannello a U per isole con bordo Slab.

U SHAPE BASE PANEL, SLAB PROFILE

U shape for counter kitchen island with Slab profile.

U BASIS PANEEL, OBERE SEITE SLAB

U panel oder für Kücheninsel mit Slab Profil.

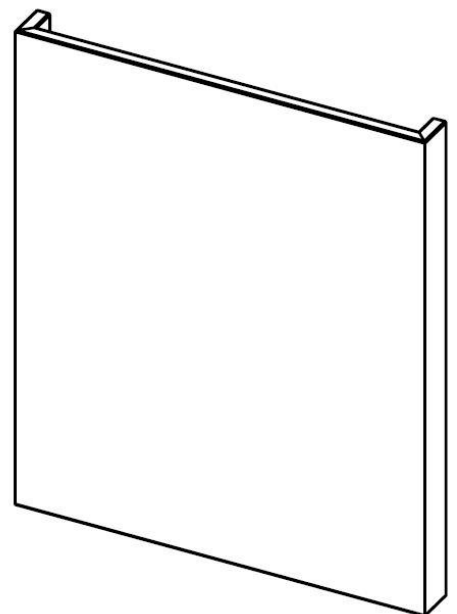
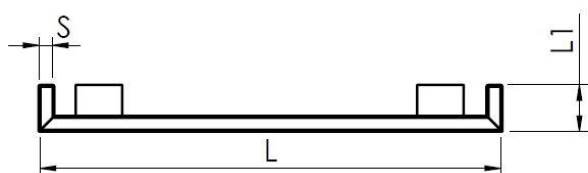
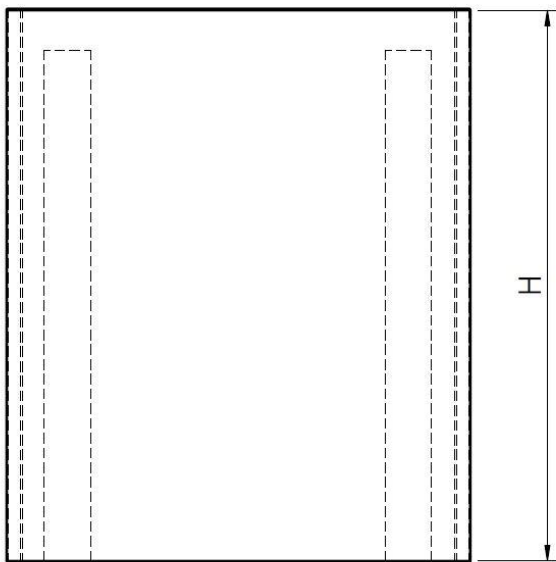

PANNELLO U BASE CHAMFER

Pannello a U per isole con bordo 30° - Chamfer.

U SHAPE BASE PANEL, CHAMFER PROFILE

U shape panel for counter kitchen island with Chamfer profile.

U BASIS PANEEL, OBERE SEITE CHAMFER

U Paneel für Kücheninsel mit Chamfer Profil.

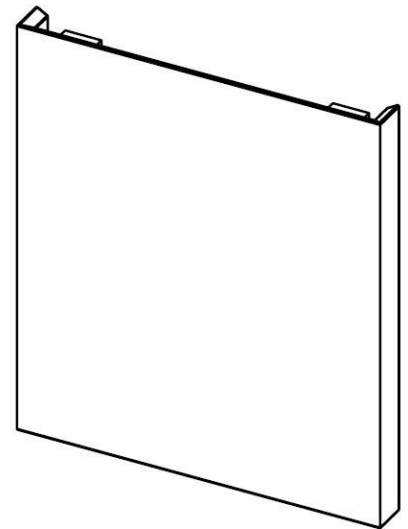
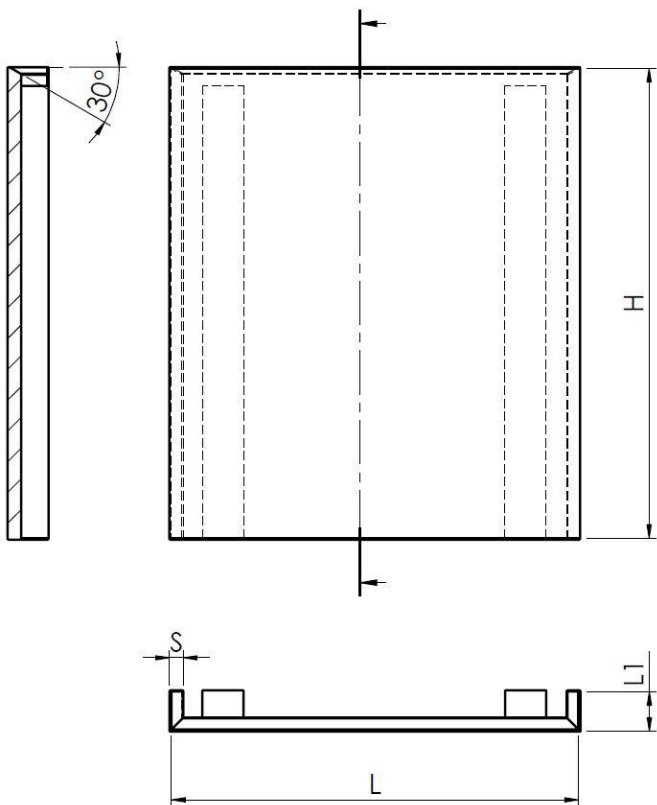

PANNELLO U BASE JPULL

Pannello a U per isole con bordo Jpull.

U SHAPE BASE PANEL, JPULL PROFILE

U shape for counter kitchen island with Jpull profile.

U BASIS PANEEL, OBERE SEITE JPULL

U Panel für Kücheninsel mit Jpull Profil.

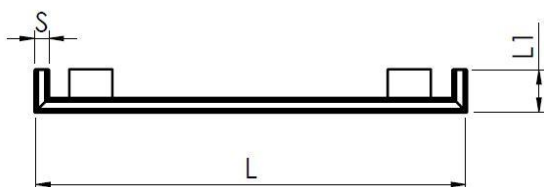
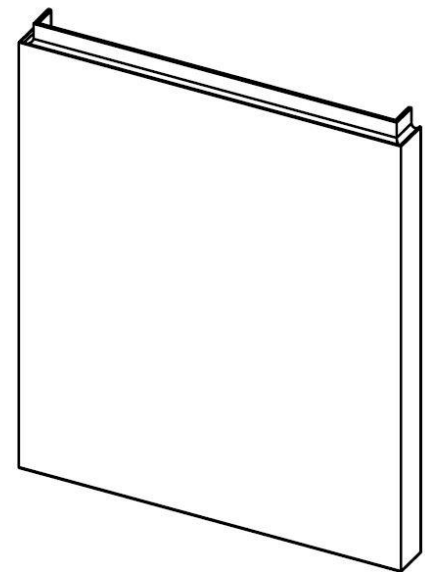
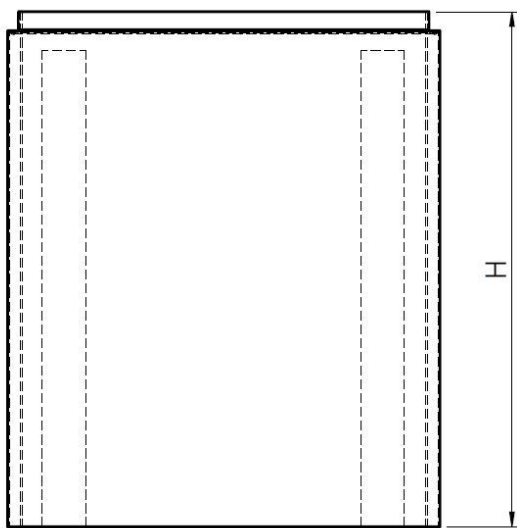

PIANO TOP SPESSORE 6 cm

Piano top pieno con spessore 6 cm e profondità da 60 a 120 cm ideale per realizzare banconi da cucina, banchi snack-colazione o piani tavolo.

Non funge da piano di lavoro.

TOP PLATE THICKNESS 6 cm

Top plate full height thickness 6 cm, depth 60-120 cm, ideal for counter kitchen tables, snack-breakfast panels or table tops.

It doesn't work as a Kitchen worktop.

TOP PLATTE STAERKE 6 cm

Top Platte voller Teil Staerke 6 cm, Tiefe 60-1210 cm, ideal fuer Kücheninsel und Küchentische.

Es funktioniert nicht als Küchenarbeitsplatte.

	Piano top spessore 6 cm
Profondità Depth	60 cm
	70 cm
	80 cm
	90 cm

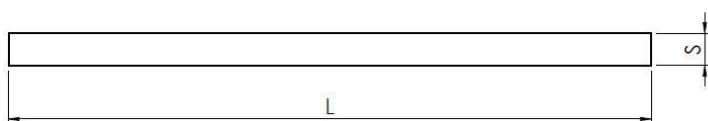
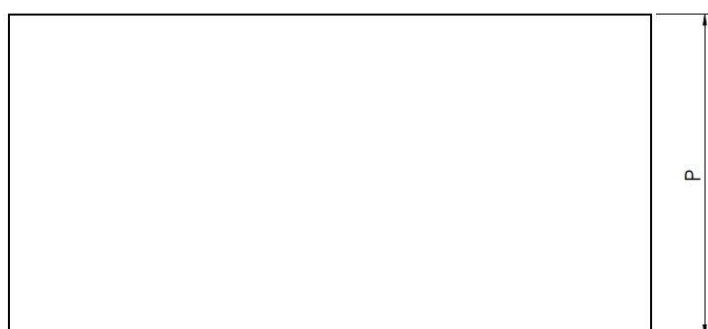
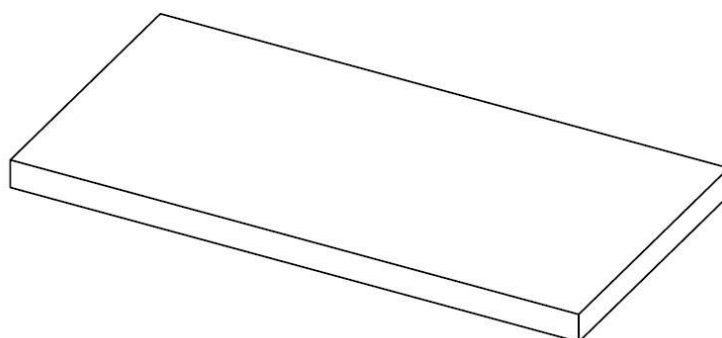

PIANO TOP SPESSORE 8 cm

Piano top folding 4 lati, vuoto sotto, con spessore 8 cm e profondità da 60 a 120 cm, ideale per realizzare banconi da cucina, banchi snack-colazione o piani tavolo.

Non funge da piano di lavoro.

TOP PLATE THICKNESS 8 cm

Top plate with 4 sides folding, empty on the bottom, thickness 8 cm, depth 60-120 cm, ideal for counter kitchen tables, snack-breakfast panels or table tops.

It doesn't work as a Kitchen worktop.

TOP PLATTE STAERKE 8 cm

Top Platte mit 4 seitigen Folding, leer unten, Stärke 8 cm, Tiefe 60-120 cm, ideal für Kücheninsel und Küchentische.

Es funktioniert nicht als Küchenarbeitsplatte.

	Piano top folding 4 lati spessore 8 cm Top plate folding thickness 8 cm
Profondità Depth	60 cm
	70 cm
	80 cm
	90 cm
	120 cm

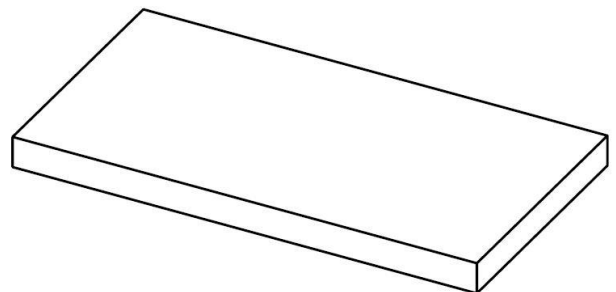
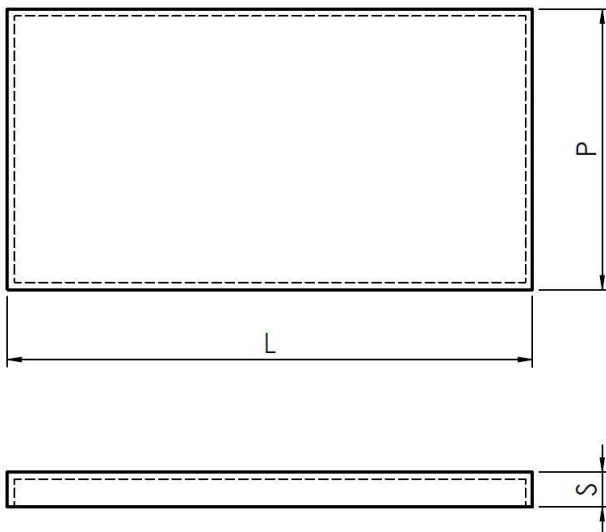

PIANO TOP SPESSORE 10 cm

Piano top folding 4 lati, vuoto sotto, con spessore 10 cm e profondità da 60 a 120 cm, ideale per realizzare banconi da cucina, banchi snack-colazione o piani tavolo.

Non funge da piano di lavoro.

TOP PLATE THICKNESS 10 cm

Top plate with 4 sides folding, empty on the bottom, thickness 10 cm, depth 60-120 cm, ideal for counter kitchen tables, snack-breakfast panels or table tops.

It doesn't work as a Kitchen worktop.

TOP PLATTE STAERKE 10 cm

Top Platte mit 4 seitigen Folding, leer unten, Stärke 10 cm, Tiefe 60-120 cm, ideal fuer Kücheninsel und Küchentische.

Es funktioniert nicht als Küchenarbeitsplatte.

	Piano top folding 4 lati spessore 10 cm Top plate folding thickness 10 cm
Profondità Depth	60 cm
	70 cm
	80 cm
	90 cm

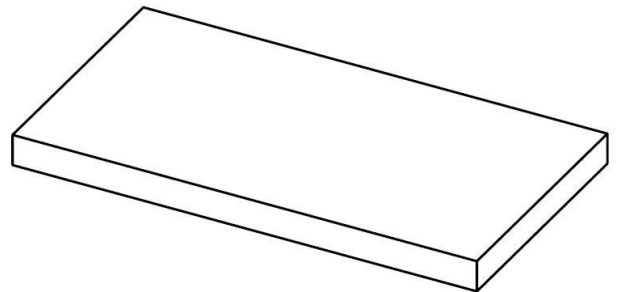
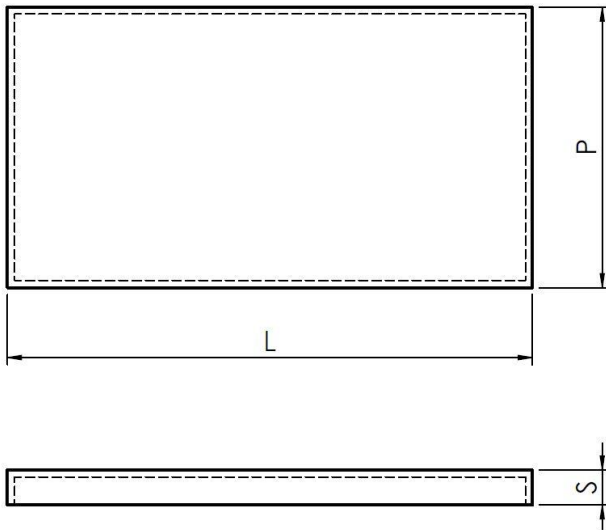

*La profondità 120 è disponibile solo nell'impiallacciato e nel melaminico

*120 depth is available only in Veneered and Melamine materials

*Tiefe 120 es ist nur verfügbar furniert

Top pieno/Full height top plate/Top Platte

Top folding 4 lati/4 sides/4seitig

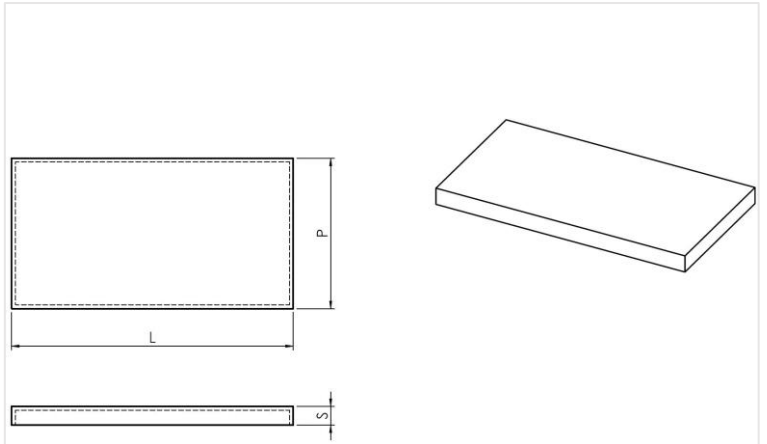
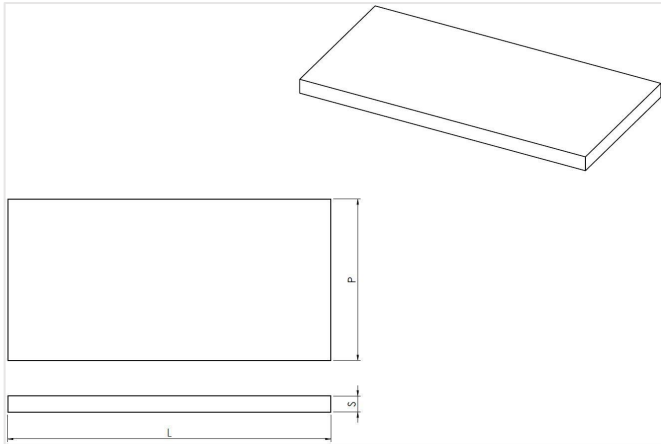

	Spessore/Thickness/Stärke	Profondità/Depth/Tiefe	Lunghezza/Length/Länge
Top pieno/full height	6 cm	600 - 1200 cm	500 - 2700 cm
Top folding 4 lati/sides/4seitig	8 o 10 cm	600 - 900 cm	500 - 2700 cm