

**ZOCCOLO H 10-15 cm**

Zoccolo da cucina H 10-15 cm.

**PLINTH H 10-15 cm**

Plinth for kitchen height 10-15 cm.

**SOCKEL H 10-15 cm**

Sockel für Küche Höhe 10-15 cm.

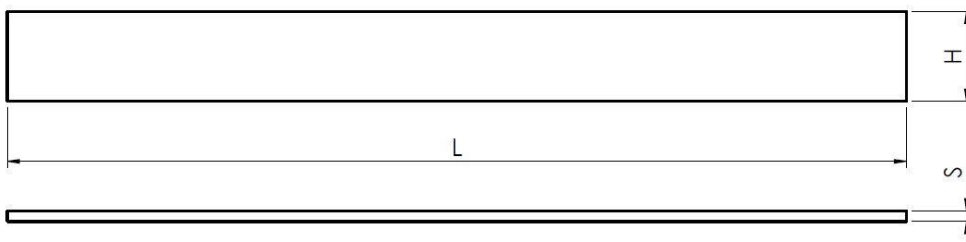
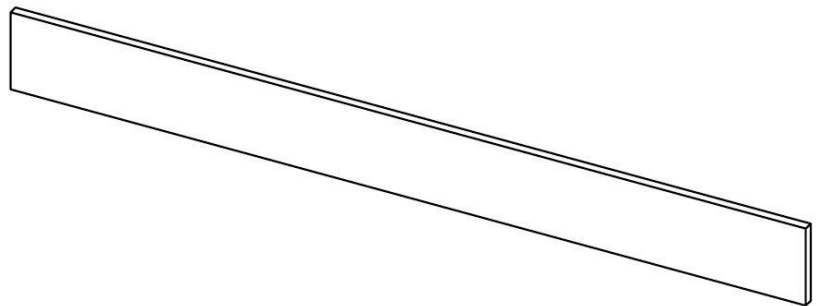

**TAMPONAMENTO**

Tamponamento per cucina.

**FILLER**

Filler for kitchens.

**FILLER**

Filler für Küche.

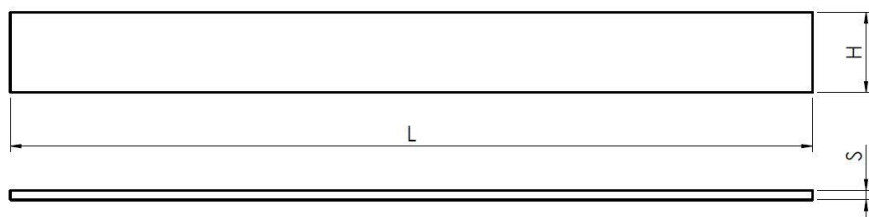
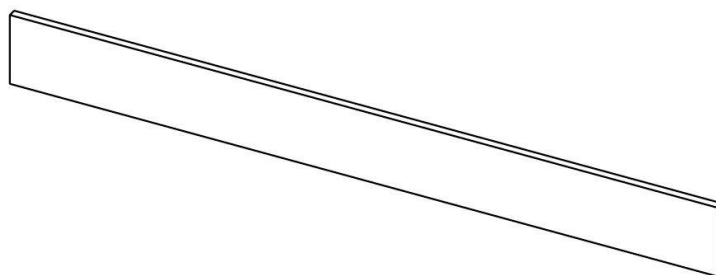

**MENSOLA SPESSORE 28 mm**

Mensola spessore 28 mm.

**SHELF THICKNESS 28 mm**

Shelf thickness 28 mm.

**REGAL STAERKE 28 mm**

Regal Stärke 28 mm.

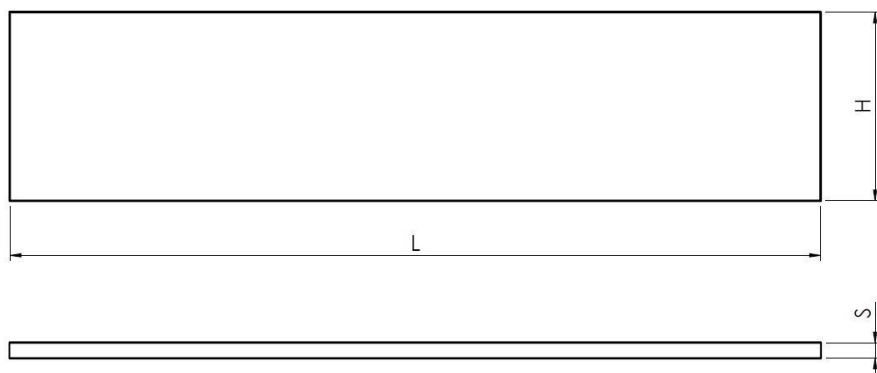
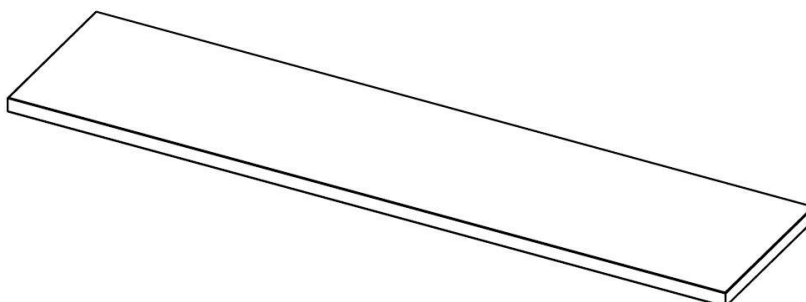

**PANNELLO CON BORDO SINISTRO 45° E SUPERIORE 30°**

Pannello per basi, pensili o isole con bordo sinistro a 45° e bordo superiore 30°.

Materiali disponibili: Impiallacciato, Laccato, Biomalta.

**PANEL WITH 1 LEFT EDGE 45° AND TOP EDGE 30°**

Panel for base, wall panel or counter kitchen island with 1 left edge 45° and top edge 30°.

Available materials: Veneered doors, Lacquered doors, Bio mortar doors.

**PANEEL MIT 1 LINKE SEITE 45° UND OBERE SEITE 30°**

Basis und Wand Paneele oder Paneele fuer Kücheninsel mit 1 linke Seite 45° und obere Seite 30°.

Verfügbare Materialien: Furnierten fronten, Lackierte fronten, Oeko-Moertel fronten.

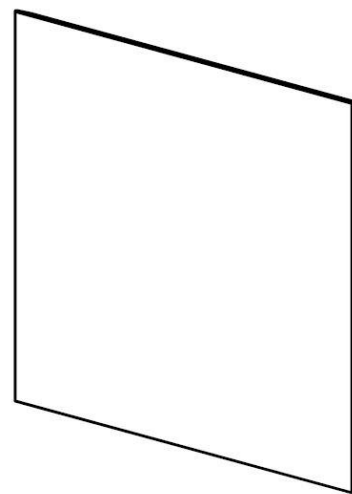
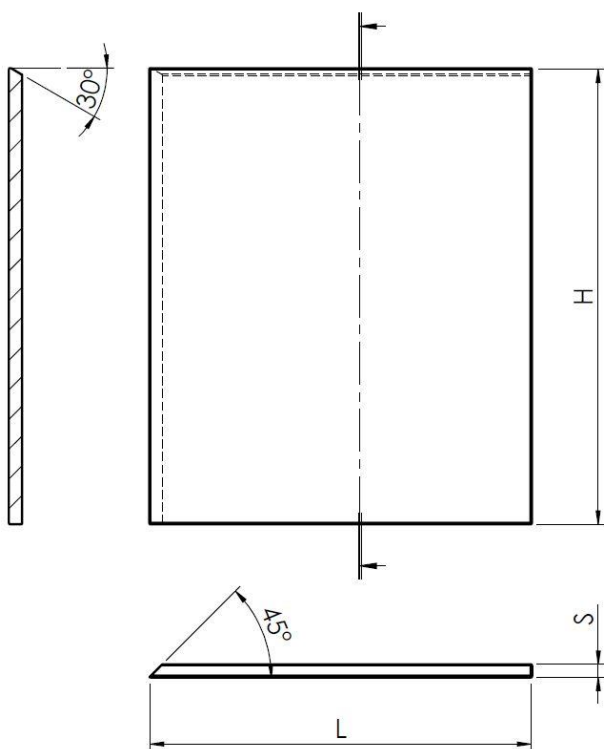

**PANNELLO CON BORDO DESTRO 45° E SUPERIORE 30°**

Pannello per basi, pensili o isole con bordo destro a 45° e bordo superiore 30°.

Materiali disponibili: Impiallacciato, Laccato, Biomalta.

**PANEL WITH 1 RIGHT EDGE 45° AND TOP EDGE 30°**

Panel for base, wall panel or counter kitchen island with 1 right edge 45° and top edge 30°.

Available materials: Veneered doors, Lacquered doors, Bio mortar doors.

**PANEEL MIT 1 RECHTE SEITE 45° UND OBERE SEITE 30°**

Basis und Wand Paneele oder Paneele fuer Kücheninsel mit 1 rechte Seite 45° und obere Seite 30°.

Verfügbare Materialien: Furnierten fronten, Lackierte fronten, Oeko-Moertel fronten.

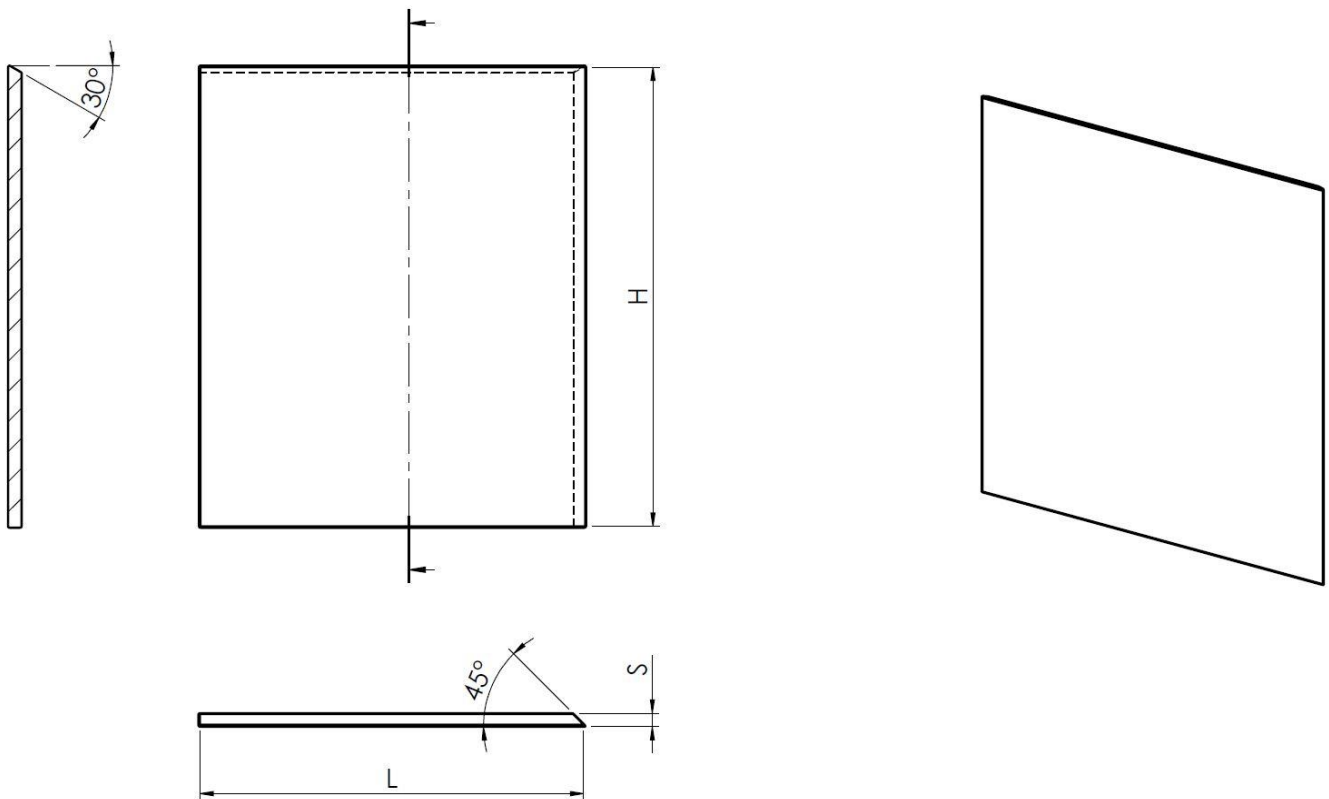

**PANNELLO CON 2 LATI 45° E SUP SLAB**

Pannello con 2 lati a 45° e bordo superiore Slab.

Materiali disponibili: Impiallacciato, Laccato, Biomalta.

**PANEL WITH 1 SIDES 45° AND TOP EDGE SLAB**

Panel for base, wall panel or counter kitchen island with 2 sides 45° and top edge Slab Profile.

Available materials: Veneered doors, Lacquered doors, Bio mortar doors.

**PANEEL MIT 2 SEITEN 45° UND OBERE SEITE SLAB**

Basis und Wand Paneele oder Paneele fuer Kücheninsel mit 2 Seiten 45° und obere Seite Slab Profil.

Verfügbare Materialien: Furnierten fronten, Lackierte fronten, Oeko-Moertel fronten.

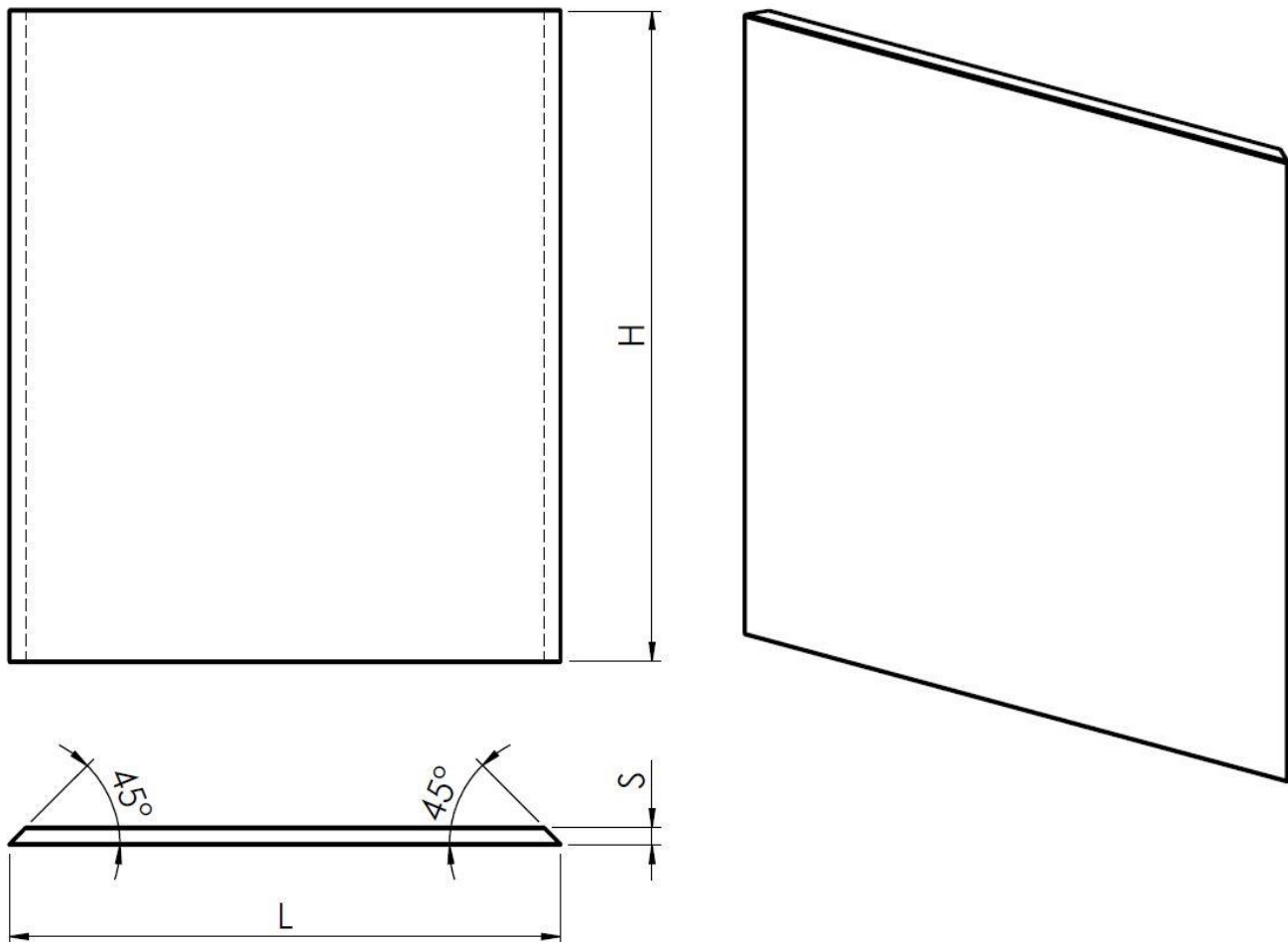

**PANNELLO CON 2 LATI 45° E SUP 30°**

Pannello con 2 lati a 45° e bordo superiore 30°.

**PANEL WITH 2 SIDES 45° AND TOP EDGE 30°**

Panel for base, wall panel or counter kitchen island with 2 sides 45° and top edge 30°.

**PANEEL MIT 2 SEITEN 45° UND OBERE SEITE 30°**

Basis und Wand Paneele oder Paneele fuer Kücheninsel mit 2 Seiten 45° und obere Seite 30°.

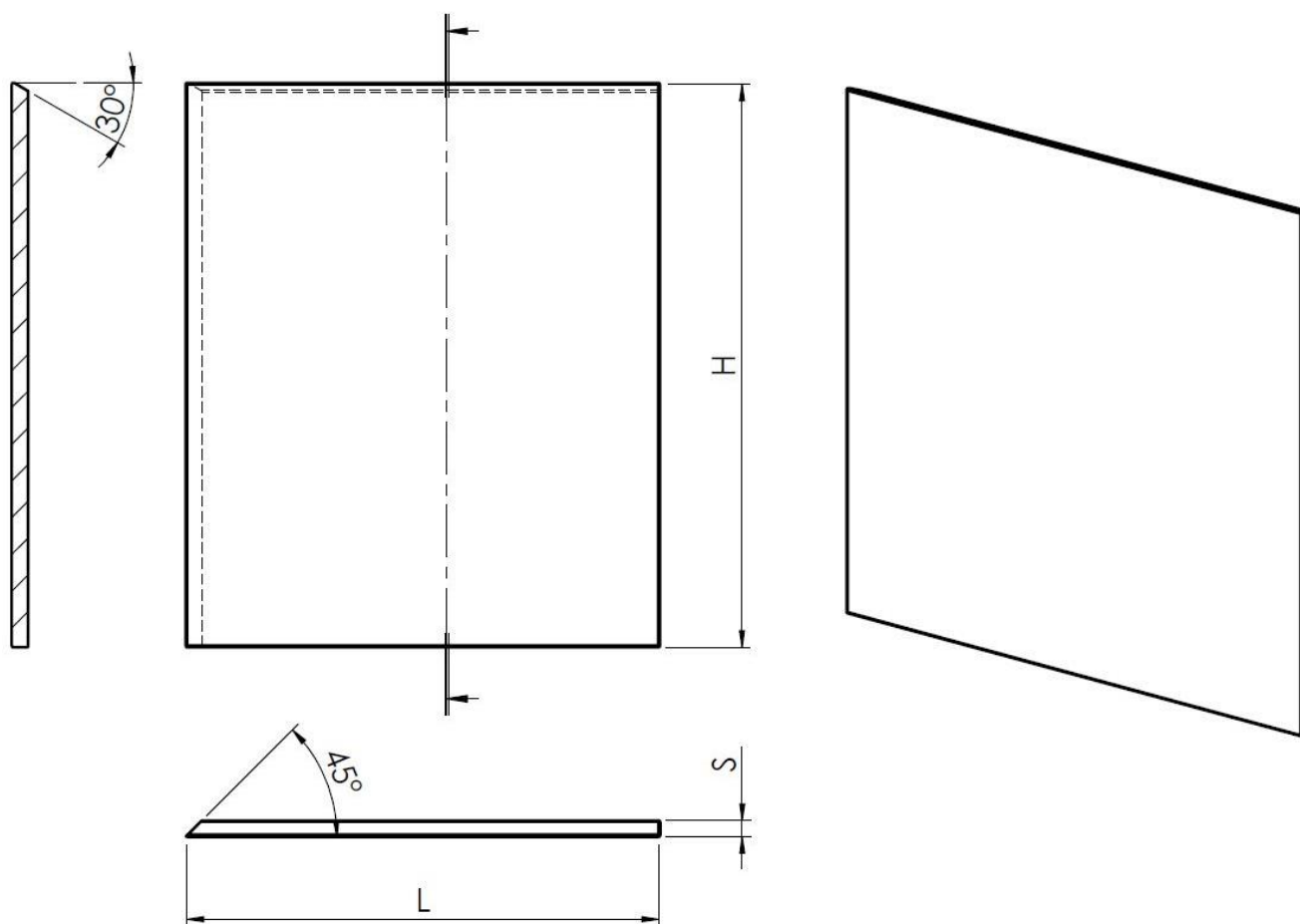

**MONTANTE ANGOLO INTERNO SLAB**

Montante angolo interno con profilo Slab.

**INTERNAL CORNER POST SLAB**

Internal Corner post Slab profile.

**INNERE ECKE PASSTUECK, SLAB PROFIL**

Innere Ecke Passtueck mit Slab Profil.

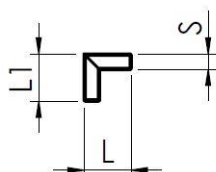
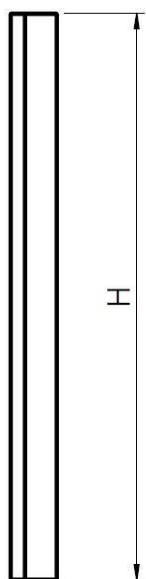



**MONTANTE ANGOLO INTERNO 30°**

Montante angolo interno con profilo Chamfer 30°.

**INTERNAL CORNER POST 30°, CHAMFER PROFILE**

Internal Corner post 30°, Chamfer profile.

**INNERE ECKE PASSTUECK 30°, CHAMFER PROFIL**

Innere Ecke Passtueck mit 30°, Chamfer Profil.

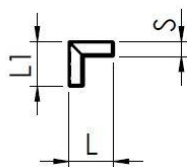
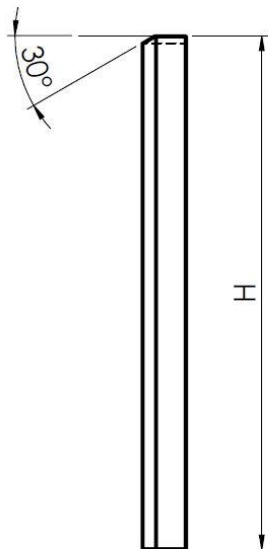

**MONTANTE ANGOLO INTERNO JPULL**

Montante angolo interno con profilo Jpull.

**INTERNAL CORNER POST JPULL**

Internal Corner post Jpull profile.

**INNERE ECKE PASSTUECK, JPULL PROFIL**

Innere Ecke Passtueck mit Jpull Profil.

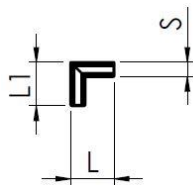
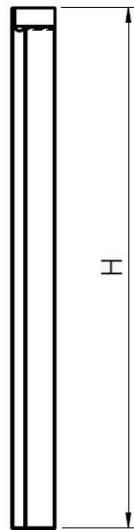

**MONTANTE ANGOLO ESTERNO SLAB**

Montante angolo esterno con profilo Slab.

**EXTERNAL CORNER POST SLAB**

External Corner post Slab profile.

**AUSSERE ECKE PASSTUECK, SLAB PROFIL**

Aussere Ecke Passtueck mit Slab Profil.

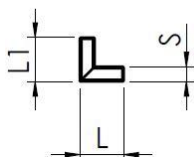
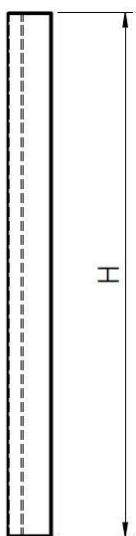

**MONTANTE ANGOLO ESTERNO 30°**

Montante angolo esterno con profilo 30° Chamfer.

**EXTERNAL CORNER POST 30°**

External Corner post 30° Chamfer Profile.

**AUSSERE ECKE PASSTUECK, 30°PROFIL**

Aussere Ecke Passtueck mit 30° Chamfer Profil.

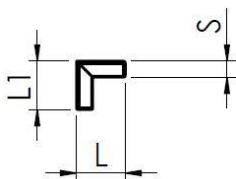
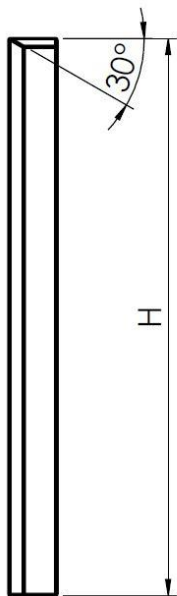

**MONTANTE ANGOLO ESTERNO JPULL**

Montante angolo esterno con profilo Jpull.

**EXTERNAL CORNER POST JPULL**

External Corner post Jpull profile.

**AUSSERE ECKE PASSTUECK, JPULL PROFIL**

Aussere Ecke Passtueck mit Jpull Profil.

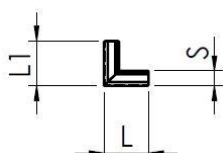
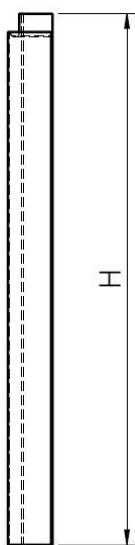

**PANNELLO L BASE E PENSILE SLAB**

Pannello a L per basi, pensili o isole con bordo Slab.

**L SHAPE BASE/WALL PANEL, SLAB PROFILE**

L shape base/wall panel or for counter kitchen island with slab profile.

**L BASIS UND WAND PANEEL, OBERE SEITE SLAB**

L Basis und Wand Paneel oder für Kücheninsel mit Slab Profil.

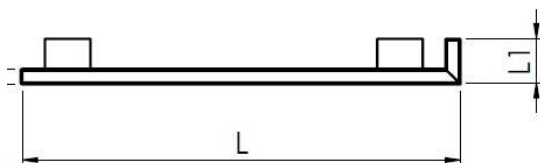
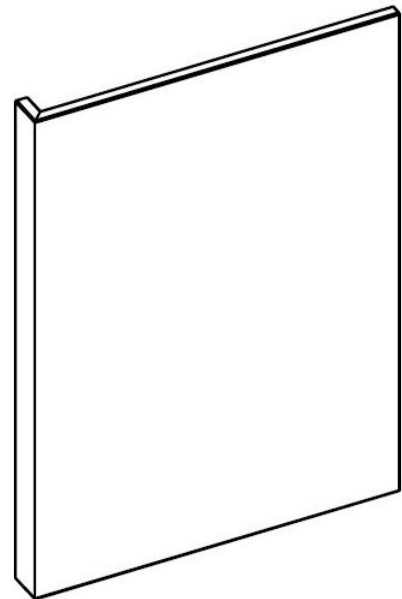
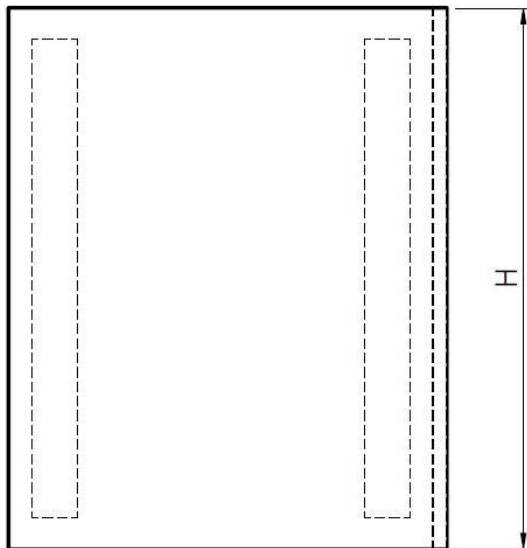

**PANNELLO L BASE DX BORDO SUPERIORE 30°**

Pannello a L destro per basi o isole, bordo superiore 30°.

**L SHAPE BASE RIGHT PANEL, TOP EDGE 30°**

L shape right panel for base and counter kitchen island, top edge 30°.

**L RECHTE BASIS PANEEL, OBERE SEITE 30°**

L rechte Basis Paneel oder für Kücheninsel mit 30° Profil.

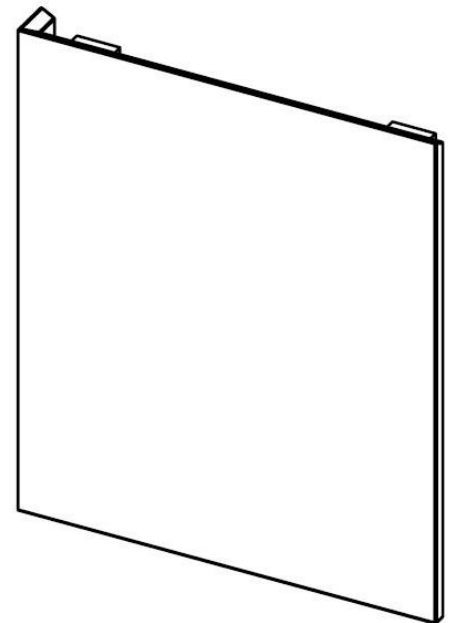
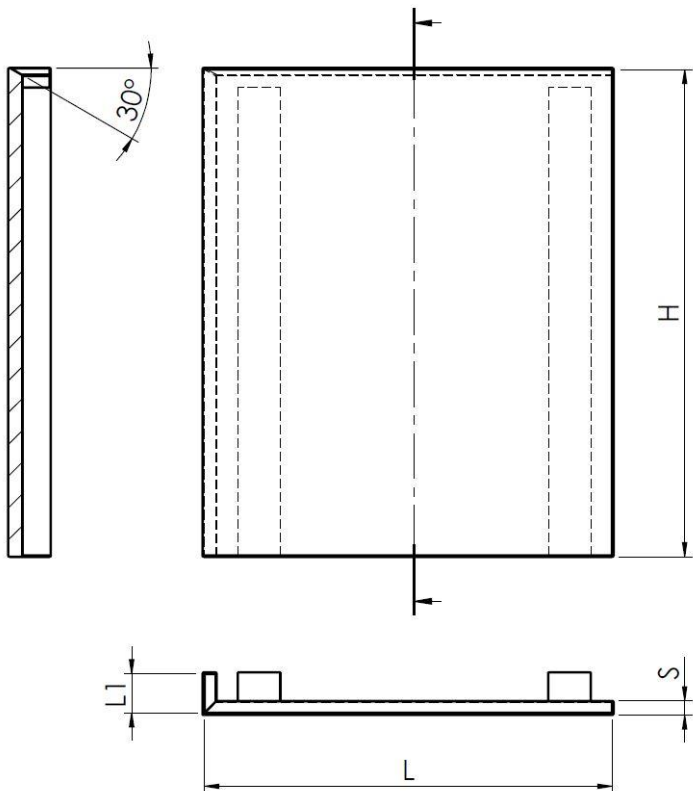

**PANNELLO L BASE SX BORDO SUPERIORE 30°**

Pannello a L sinistro per basi o isole, bordo superiore 30°.

**L SHAPE BASE LEFT PANEL, TOP EDGE 30°**

L shape left panel for base and counter kitchen island, top edge 30°.

**L LINKS BASIS PANEEL, OBERE SEITE 30°**

L linke Basis Paneel oder für Kücheninsel mit 30° Profil.

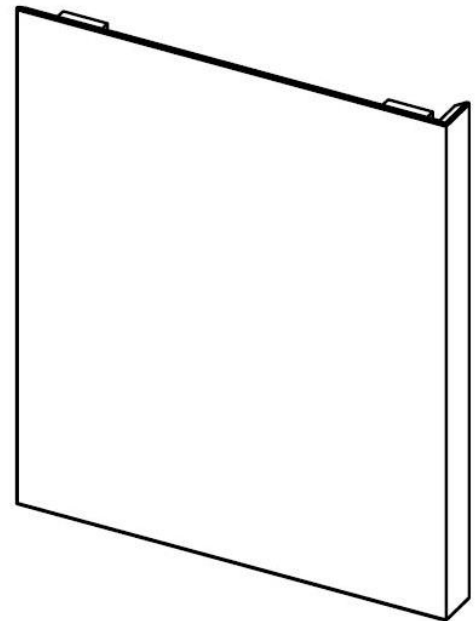
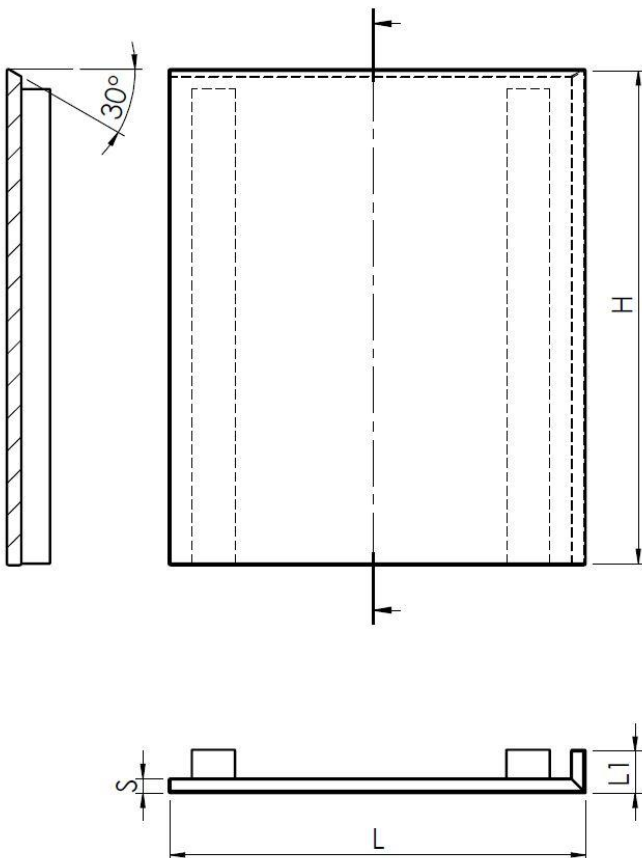



**PANNELLO L BASE DX BORDO SUPERIORE GOLA1**

Pannello a L destro per basi o isole, bordo superiore Gola1.

**L SHAPE BASE RIGHT PANEL, TOP EDGE JPULL**

L shape right panel for base and counter kitchen island, top edge jpull

**L RECHTE BASIS PANEEL, OBERE SEITE 30°**

L rechte Basis Paneel oder für Kücheninsel mit jpull Profil.

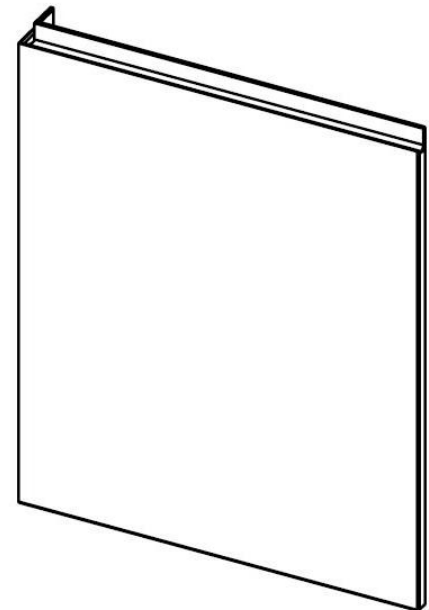
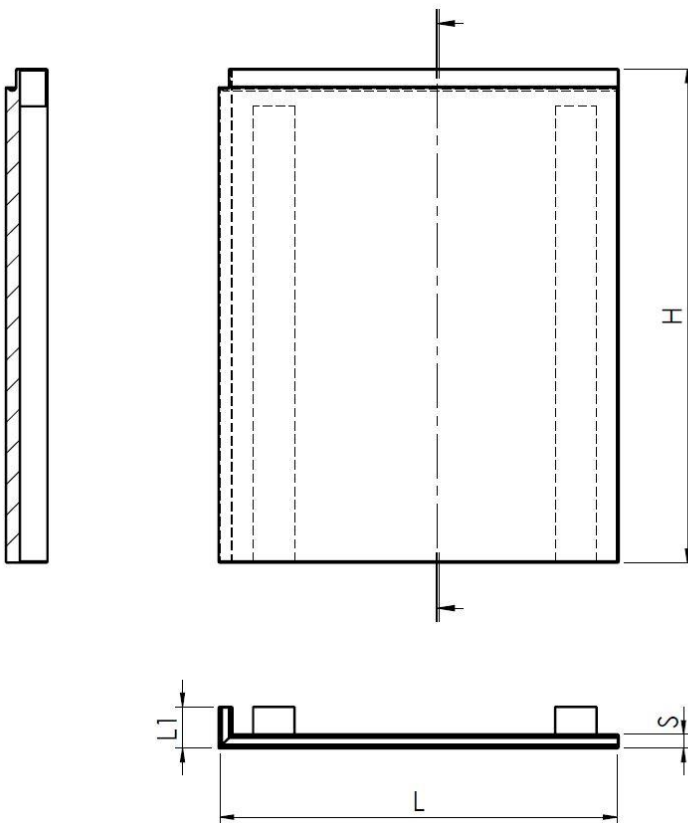

**PANNELLO L BASE SX BORDO SUPERIORE GOLA1**

Pannello a L sinistro per basi o isole, bordo superiore Gola1.

**L SHAPE BASE LEFT PANEL, TOP EDGE JPULL**

L shape left panel for base and counter kitchen island, top edge jpull.

**L LINKS BASIS PANEEL, OBERE SEITE JPULL**

L linke Basis Paneel oder für Kücheninsel mit Jpull Profil.

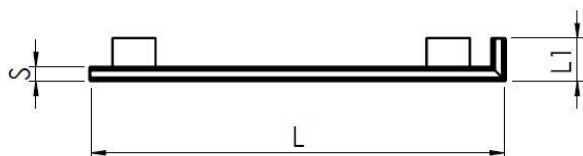
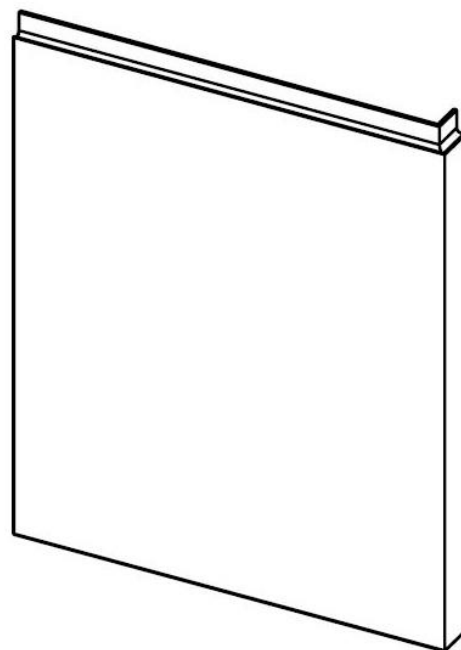
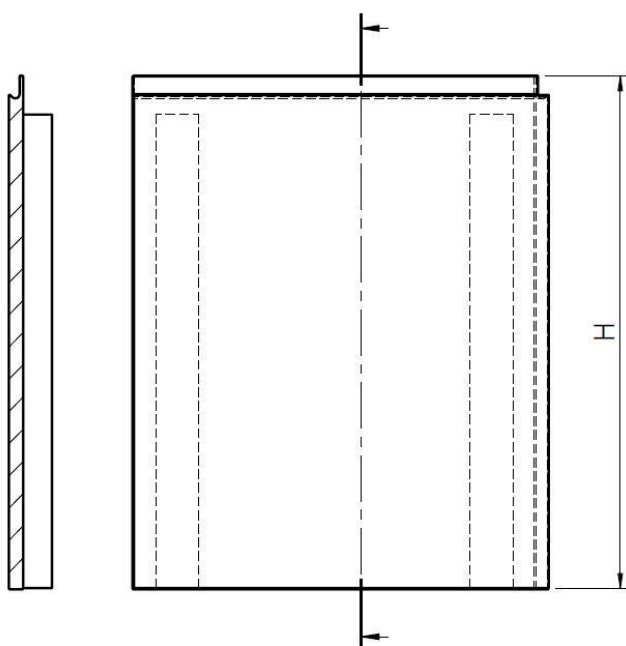

**PANNELLO L PENSILE SX BORDO INFERIORE 30°**

Pannello a L sinistro per pensile, bordo inferiore 30°.

**L SHAPE WALL LEFT PANEL, BOTTOM EDGE 30°**

L shape left panel for shape wall panel, bottom edge 30°.

**L LINKS WAND PANEEL, UNTERE SEITE 30°**

L links Wand Paneel mit untere Seite 30° Profil.

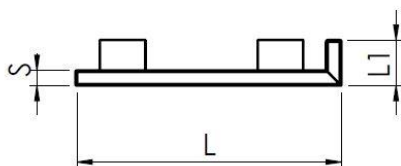
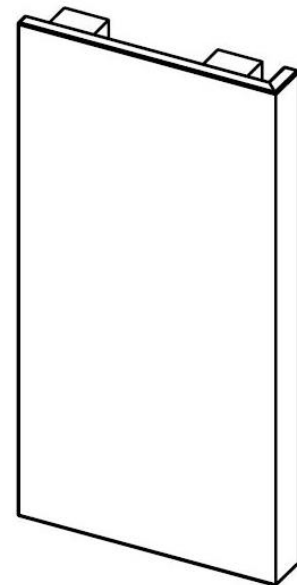
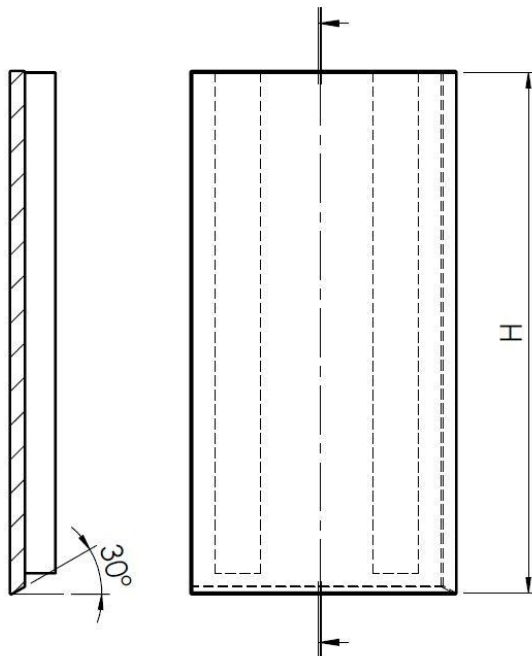

**PANNELLO L PENSILE DX BORDO INFERIORE 30°**

Pannello a L destro per pensili, bordo inferiore 30°.

**L SHAPE WALL RIGHT PANEL, BOTTOM EDGE 30°**

L shape wall right panel, bottom edge 30°.

**L RECHTE WAND PANEEL, UNTERE SEITE 30°**

L rechte Wand Paneel mit 30° Profil.

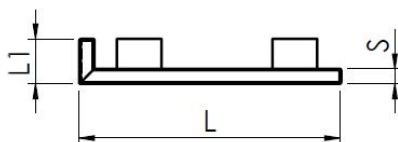
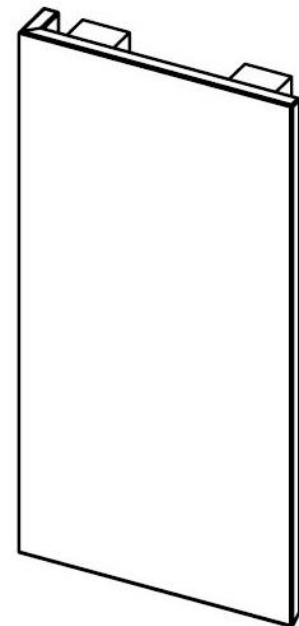
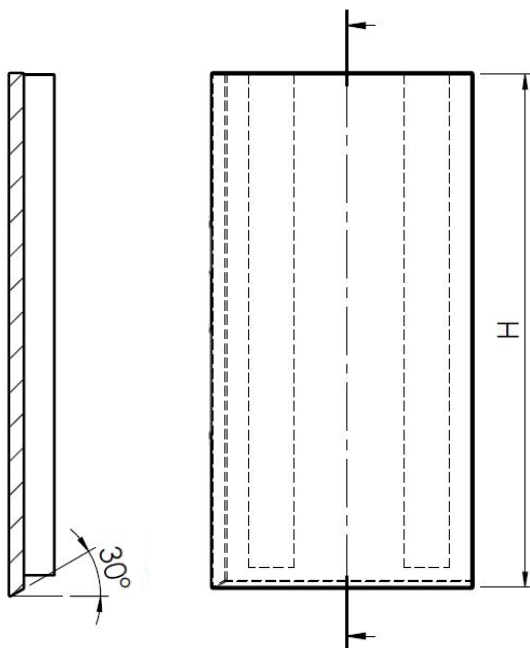

**PANNELLO L PENSILE SX BORDO INFERIORE GOL1**

Pannello a L sinistro per pensile, bordo inferiore Gola1.

**L SHAPE WALL LEFT PANEL, BOTTOM EDGE JPULL**

L shape left panel for shape wall panel, bottom edge jpull.

**L LINKS WAND PANEEL, UNTERE JPULL**

L links Wand Paneel mit untere Seite Jpull Profil.

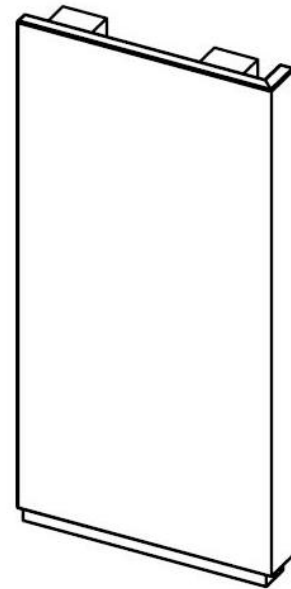
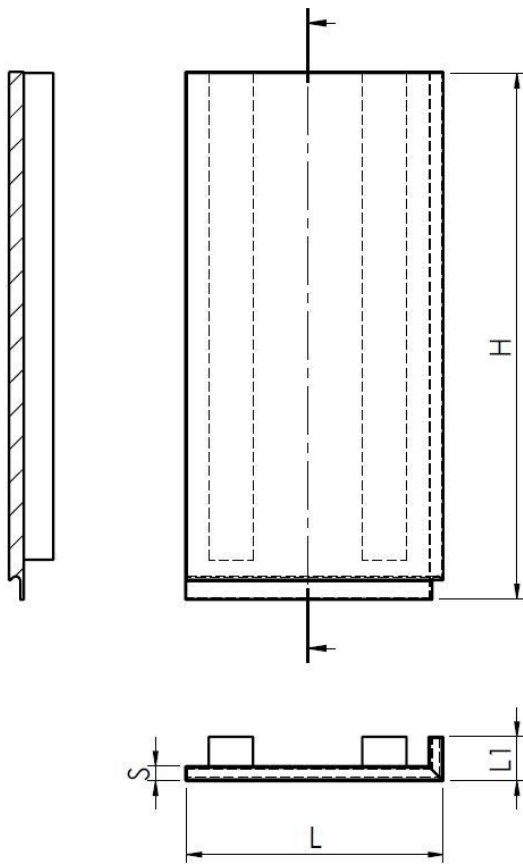

**PANNELLO L PENSILE DX BORDO INFERIORE GOLA1**

Pannello a L destro per pensili, bordo inferiore Gola.

**L SHAPE WALL RIGHT PANEL, BOTTOM EDGE JPULL**

L shape wall right panel, bottom edge jpull.

**L RECHTE WAND PANEEL, UNTERE SEITE JPULL**

L rechte Wand Paneel mit Jpull Profil.

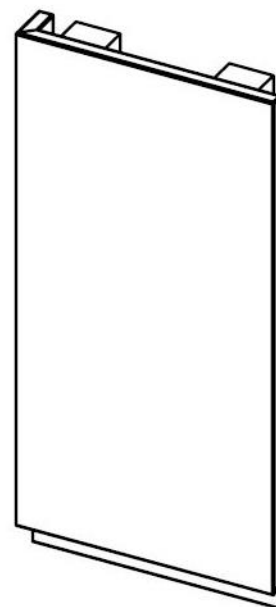
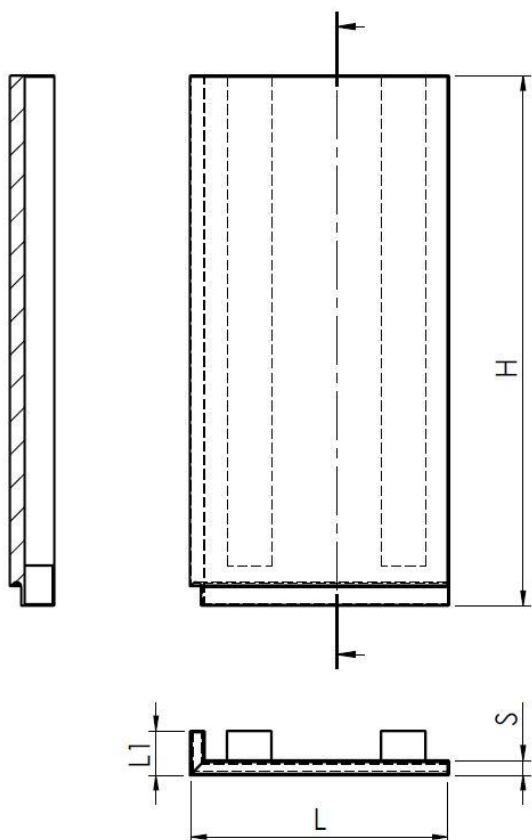

**PANNELLO U BASE SLAB**

Pannello a U per isole con bordo Slab.

**U SHAPE BASE PANEL, SLAB PROFILE**

U shape for counter kitchen island with Slab profile.

**U BASIS PANEEL, OBERE SEITE SLAB**

U paneel oder für Kücheninsel mit Slab Profil.

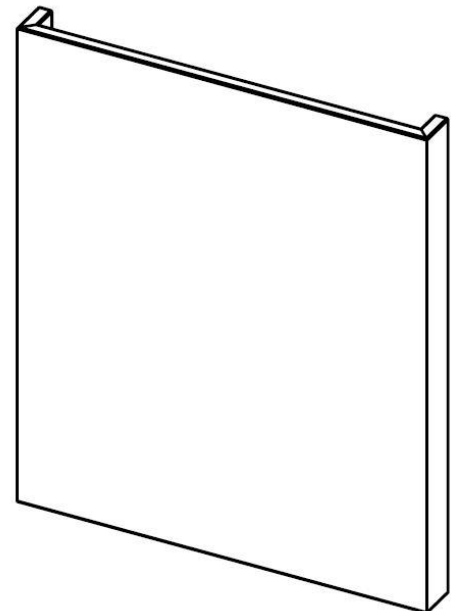
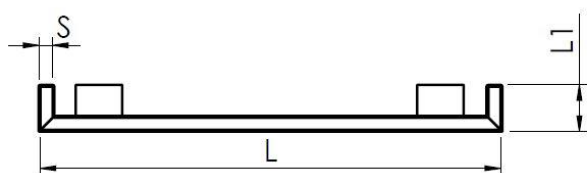
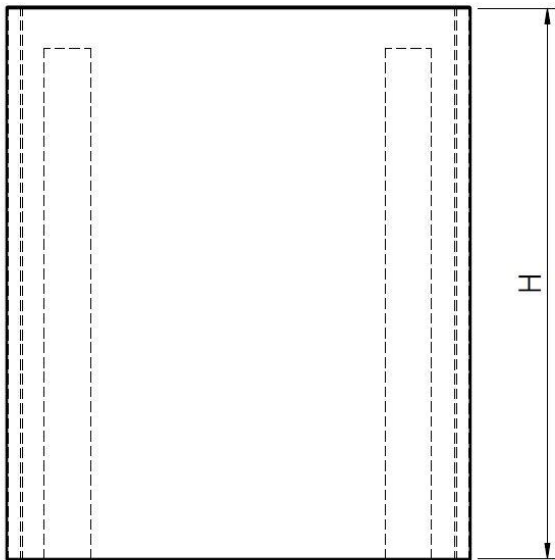

**PANNELLO U BASE CHAMFER**

Pannello a U per isole con bordo 30° - Chamfer.

**U SHAPE BASE PANEL, CHAMFER PROFILE**

U shape panel for counter kitchen island with Chamfer profile.

**U BASIS PANEEL, OBERE SEITE CHAMFER**

U Panel für Kücheninsel mit Chamfer Profil.

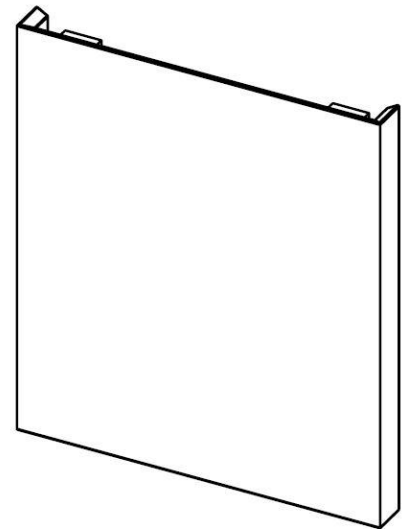
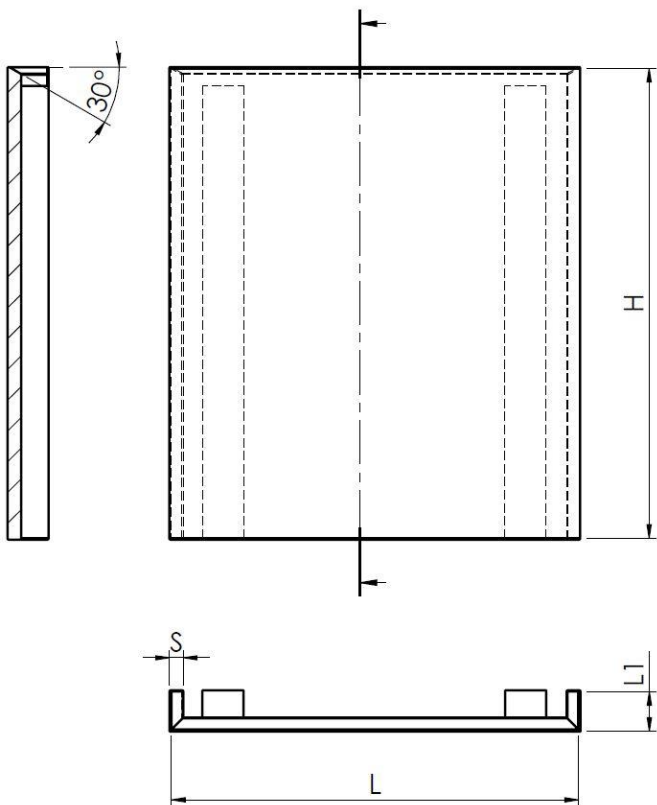



**PANNELLO U BASE JPULL**

Pannello a U per isole con bordo Jpull.

**U SHAPE BASE PANEL, JPULL PROFILE**

U shape for counter kitchen island with Jpull profile.

**U BASIS PANEEL, OBERE SEITE JPULL**

U Panel für Kücheninsel mit Jpull Profil.

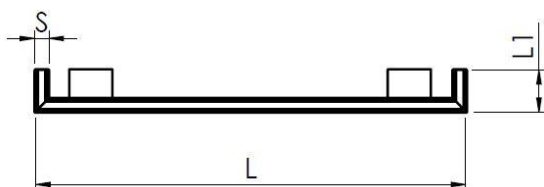
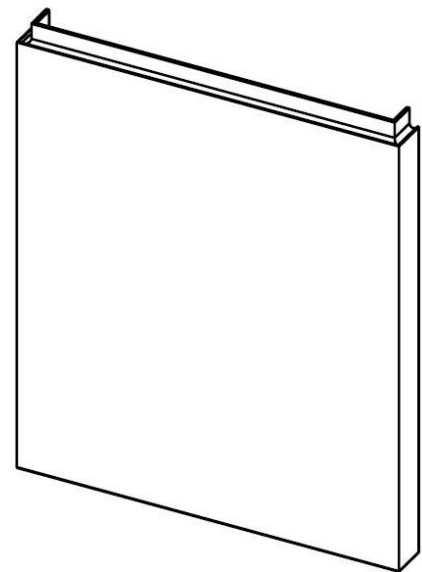
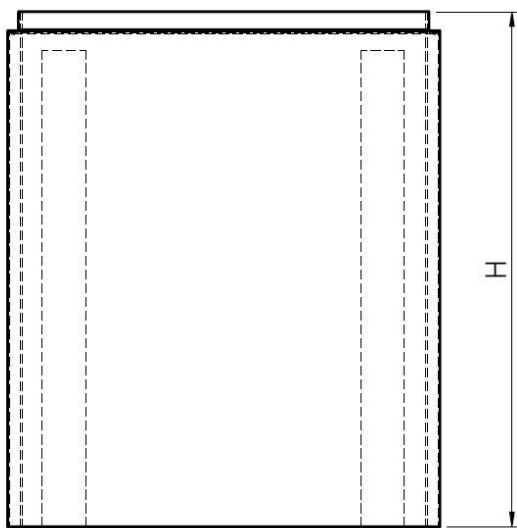

**PIANO TOP SPESSORE 6 cm**

Piano top pieno con spessore 6 cm e profondità da 60 a 120 cm ideale per realizzare banconi da cucina, banchi snack-colazione o piani tavolo.

Non funge da piano di lavoro.

**TOP PLATE THICKNESS 6 cm**

Top plate full height thickness 6 cm, depth 60-120 cm, ideal for counter kitchen tables, snack-breakfast panels or table tops.

It doesn't work as a Kitchen worktop.

**TOP PLATTE STAERKE 6 cm**

Top Platte voller Teil Staerke 6 cm, Tiefe 60-1210 cm, ideal fuer Kücheninsel und Küchentische.

Es funktioniert nicht als Küchenarbeitsplatte.

	Piano top spessore 6 cm
Profondità Depth	60 cm
	70 cm
	80 cm
	90 cm
	120 cm

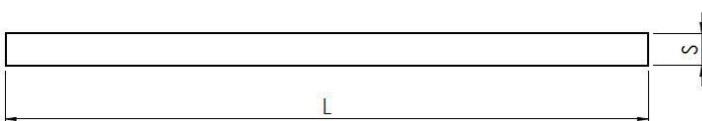
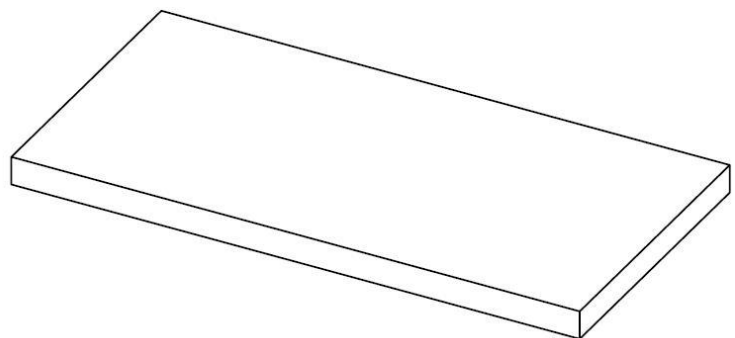

**PIANO TOP SPESSORE 8 cm**

Piano top folding 4 lati, vuoto sotto, con spessore 8 cm e profondità da 60 a 120 cm, ideale per realizzare banconi da cucina, banchi snack-colazione o piani tavolo.

Non funge da piano di lavoro.

**TOP PLATE THICKNESS 8 cm**

Top plate with 4 sides folding, empty on the bottom, thickness 8 cm, depth 60-120 cm, ideal for counter kitchen tables, snack-breakfast panels or table tops.

It doesn't work as a Kitchen worktop.

**TOP PLATTE STAERKE 8 cm**

Top Platte mit 4 seitigen Folding, leer unten, Stärke 8 cm, Tiefe 60-120 cm, ideal für Kücheninsel und Küchentische.

Es funktioniert nicht als Küchenarbeitsplatte.

	Piano top folding 4 lati spessore 8 cm Top plate folding thickness 8 cm
Profondità Depth	60 cm
	70 cm
	80 cm
	90 cm
	120 cm

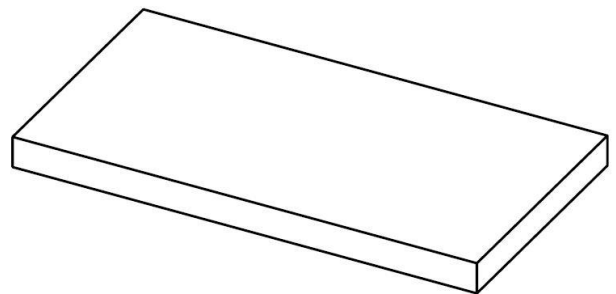
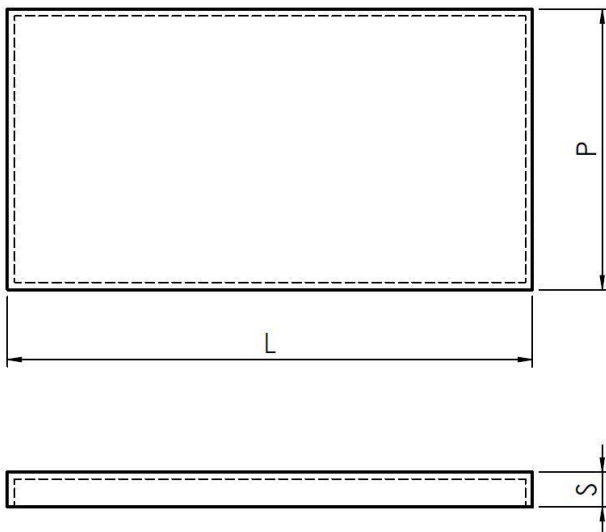

**PIANO TOP SPESSORE 10 cm**

Piano top folding 4 lati, vuoto sotto, con spessore 10 cm e profondità da 60 a 120 cm  
 ideale per realizzare banconi da cucina, banchi snack-colazione o piani tavolo.

Non funge da piano di lavoro.

**TOP PLATE THICKNESS 10 cm**

Top plate with 4 sides folding, empty on the bottom, thickness 10 cm,  
 depth 60-120 cm, ideal for counter kitchen tables, snack-breakfast panels or table tops.

It doesn't work as a Kitchen worktop.

**TOP PLATTE STAERKE 10 cm**

Top Platte mit 4 seitigen Folding, leer unten, Stärke 10 cm, Tiefe 60-120 cm, ideal fuer Kücheninsel und Küchentische.

Es funktioniert nicht als Küchenarbeitsplatte.

	Piano top folding 4 lati spessore 10 cm Top plate folding thickness 10 cm
Profondità Depth	60 cm
	70 cm
	80 cm
	90 cm
	120 cm

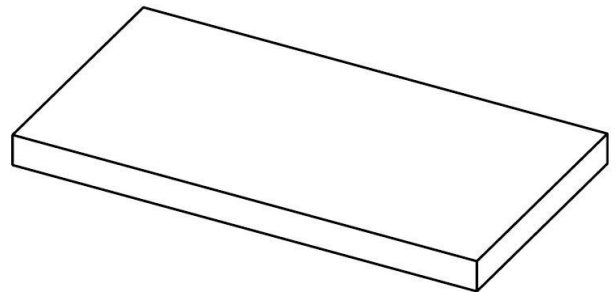
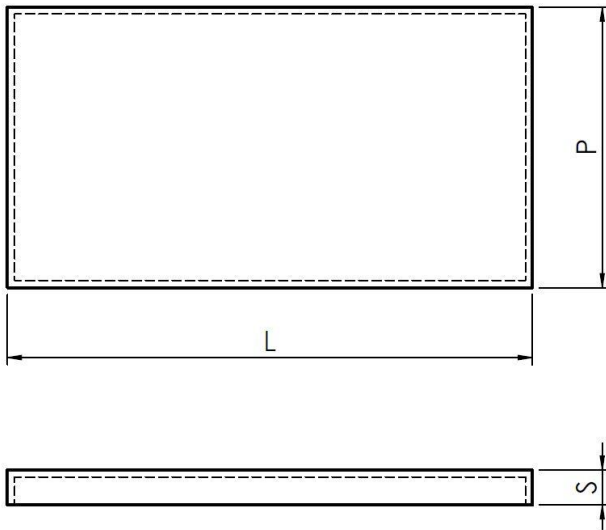

\*La profondità 120 è disponibile solo nell'impiallacciato e nel melaminico

\*120 depth is available only in Veneered and Melamine materials

\*Tiefe 120 es ist nur verfügbar furniert

Top pieno/Full height top plate/Top Platte

Top folding 4 lati/4 sides/4seitig

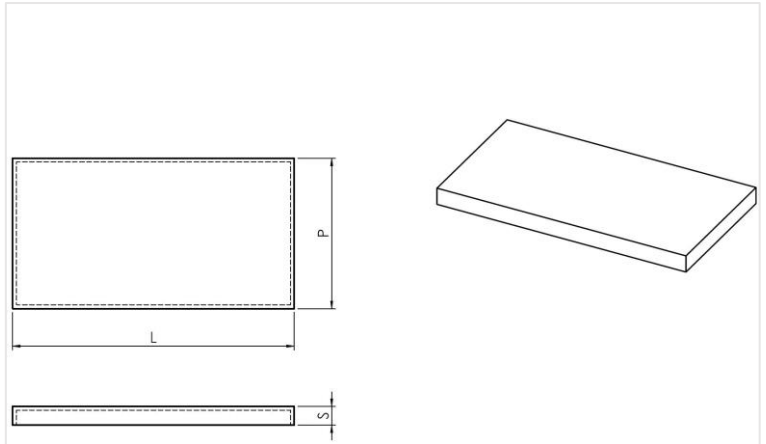
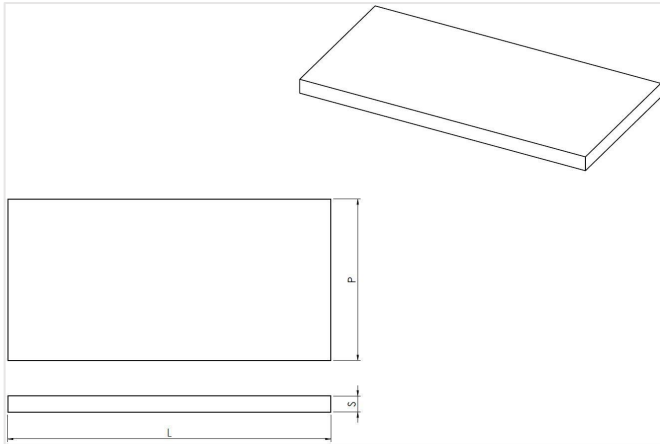

	Spessore/Thickness/Stärke	Profondità/Depth/Tiefe	Lunghezza/Length/Länge
Top pieno/full height	6 cm	600 - 1200 cm	500 - 2700 cm
Top folding 4 lati/sides/4seitig	8 o 10 cm	600 - 1200 cm	500 - 2700 cm